

# FORD PUMA





# THE SIMPLE WAY TO DRIVE A NEW FORD PUMA

**1** EXPLORE

**2** SELECT

**3** PERSONALISE

**4** SPECIFICATIONS

**5** PURCHASE

Vehicle shown features accessories, available at extra cost.

*Puma ST-Line X shown in Desert Island Blue exclusive body colour (optional) with 19" 5-spoke Matt Black machined alloy wheels (optional) and Black contrast roof (optional).*





# 1 EXPLORE

## BUILT TO PERFORM

Developed by the Ford Performance team, the sensational new Puma ST charges hard with its 200 PS (149kW) 1.5-litre Ford EcoBoost engine, delivering 0-62 mph acceleration in just 6.7 seconds. Sophisticated Sports Technologies include a limited slip differential (option), patented force vectoring springs and a unique steering rack to help keep you securely in touch with the road. Performance enhancements and aggressive styling help to set Puma ST apart, while its innovative 80-litre\* Ford MegaBox underfloor stowage compartment provides everyday practicality.

\*Cargo and load capacity limited by weight and weight distribution.

*Puma ST shown in Mean Green ST exclusive body colour (optional) and 19" 5x2 spoke Magnetite machined alloy wheels (standard).*





# 1 EXPLORE

## ELECTRIFIED PERFORMANCE

### PUMA ECOBOOST HYBRID

Puma EcoBoost Hybrid features exciting mild hybrid technology that reduces CO<sub>2</sub> emissions, optimises fuel efficiency, and delivers a more involving drive\*. The powertrain seamlessly integrates electric torque with a choice of three-cylinder petrol engines – putting up to 155 PS (116 kW) at your disposal. While regenerative braking reclaims energy as you slow down and uses it to deliver punchier performance as you accelerate.

The 7-speed automatic, dual-clutch transmission can make city driving in stop-start traffic less demanding. In addition, fast, seamless gear changes complement the hybrid powertrain's electrically boosted performance to further enhance your enjoyment.

*Puma ST-Line Vignale shown in Magnetic exclusive body colour (optional) and 18" 10-spoke Absolute Black machined alloy wheels (standard).*

\*For further fuel economy and emissions information, please refer to the specifications section.



# 1 EXPLORE

## A CLEVER USE OF SPACE

### SURPRISINGLY ACCOMMODATING

Life in the city requires an inventive approach to how you occupy space. The new Puma embraces this way of thinking. Aside from being so pleasing to the eye, it also delivers real functionality within the details of its design.

To start with, access to your loadspace is easy even with your hands full. With your keys in your pocket or bag, a simple kicking motion beneath the rear bumper can activate Puma's hands-free tailgate (optional). While the adaptive rear parcel shelf is not fixed to the second row of seats and raises with the tailgate, it can open and allow room for larger storage items.

But what's really clever is the Puma loadspace itself, which incorporates an innovative new MegaBox compartment. Not only providing an extra 80L of storage space if needed<sup>‡</sup>, the MegaBox also features a waterproof lining and even a drain hole. So if you're an active person, it's the ideal space to store wet or muddy gear after your park run and adds so much space you could even stand taller items upright in it, such as a standard size golf club bag.

<sup>‡</sup>MegaBox load volume depends on vehicle specification.

*Puma ST-Line X shown in Desert Island Blue exclusive colour (optional) and 19" 5-spoke Matt Black machined alloy wheels (optional).*







## 1 EXPLORE

# A WAY FORWARD

## PUTTING YOU IN CONTROL

With clever features and innovative technologies, the Ford Puma puts you in complete control. From the 12.3" full digital instrument cluster and advanced 8" touchscreen display, to a host of additional services and features available through your SYNC 3 infotainment system and FordPass Connect embedded modem – every element has been designed to make your drive as effortless as possible.

(FordPass Connect is available on the initial free trial period, after which subscription charges may apply).

Don't drive while distracted. Use voice-operated systems when possible; don't use handheld devices while driving. Some features may be locked out while the vehicle is in gear. Not all features are compatible with all phones.

*Puma ST-Line X shown with standard partial premium-feel Sensico® trim (fabric seat cushion centre and back lower panel inserts, partial premium-feel Sensico® seat cushion front and back centre panel inserts and bolsters, and seatback bolsters, with vinyl seat facings).*



*Puma ST-Line Vignale shown in Magnetic exclusive body colour (optional) and 18" 10-spoke Absolute Black machined alloy wheels (standard).*







**1** EXPLORE

## **PURE DRIVING ENJOYMENT**

### **PUMA ST-LINE VIGNALE**

Get more out of every drive with the dynamic new Puma ST-Line Vignale. From its dramatic 18" 10-spoke Absolute Black machined alloy wheels to its full-LED headlights and sports-style bumpers (standard), it quietly demands attention in any setting. While behind the wheel, it will reward even the keenest driver with its nimble handling, impressive ride comfort and spirited performance.

*Puma ST-Line Vignale shown in Magnetic exclusive body colour (optional).*



## STYLE AND INGENUITY

### CRAFTED FOR YOUR COMFORT

The stylishly comfortable interior of Ford Puma ST-Line Vignale provides a warm welcome. Seats are trimmed in sporty, high-end premium perforated Sensico with metal grey stitching. While within this refined environment, you can enjoy the balanced output of the 10-speaker B&O Sound System.

- **Panorama roof** lets the light flood in to enhance the feeling of spaciousness. Providing fresh air when opened, the sliding glass has a solar reflective coating to help keep the interior cool when closed, while an internal sunblind provides extra shade when you need it (option)
- **Dual-clutch 7-speed automatic transmission** adds a new level of refinement, with smooth gear changes and responsive performance (option)



*Puma ST-Line Vignale shown in Premium Sensico in Ebony with Panorama Roof (optional).*



# 1 EXPLORE

## EXHILARATING DRIVE

### PERFORMANCE TECHNOLOGY AND STYLE

Puma ST's bold sports styling features a Ford Performance-embossed splitter integrated into the front bumper that increases front-end downforce by almost 80 per cent for great stability and traction. A large rear roof spoiler further aids Puma's aerodynamic performance, while a distinctive diffuser is incorporated into the rear bumper.

The free-flowing exhaust system with dual stainless steel tailpipes helps to maximise performance, and includes active exhaust valve technology that can amplify the three-cylinder engine's naturally sporty sound. Puma ST also features four Selectable Drive Modes, including Sport mode and – for the first time on a Ford Performance vehicle – Eco mode, for the ultimate Puma driving experience.

*Puma ST in Mean Green exclusive body colour (optional) with 19" 5x2 spoke Magnetite machined alloy wheels (standard and accessory).*



## TAKE CONTROL

### PUTTING YOU IN THE DRIVER'S SEAT

The sporting lineage of the Puma ST continues inside. New AGR-certified Ford Performance seats (with partial Sensico® trim and Ford Performance stitch detailing) cosset you through every twist and turn in the road, allowing you to stay fully focussed and enjoy the ride. And if you are a track-day enthusiast, you can get the most out of every high-speed corner and challenging chicane, in full confidence the seats will keep you firmly in place.

#### Ergonomic seats with AGR certification\*\*

Ergonomically designed front seats with AGR accreditation – ideal for your back and for comfort on longer journeys. An AGR classification is the mark of a particularly high standard of back-friendly product. The AGR association researches the prevention of backache, and is widely supported by doctors and therapists. (Standard on ST)

\*\*The AGR quality cachet (Aktion Gesunder Rücken = Campaign for Healthier Backs): Certified and recommended by Association Forum Healthy Back – Better Living and Federal Association of German Back Schools. More information: AGR e.V., Stader Str. 6, D - 27432 Bremervörde, Phone + 49 4761/926 358 0.

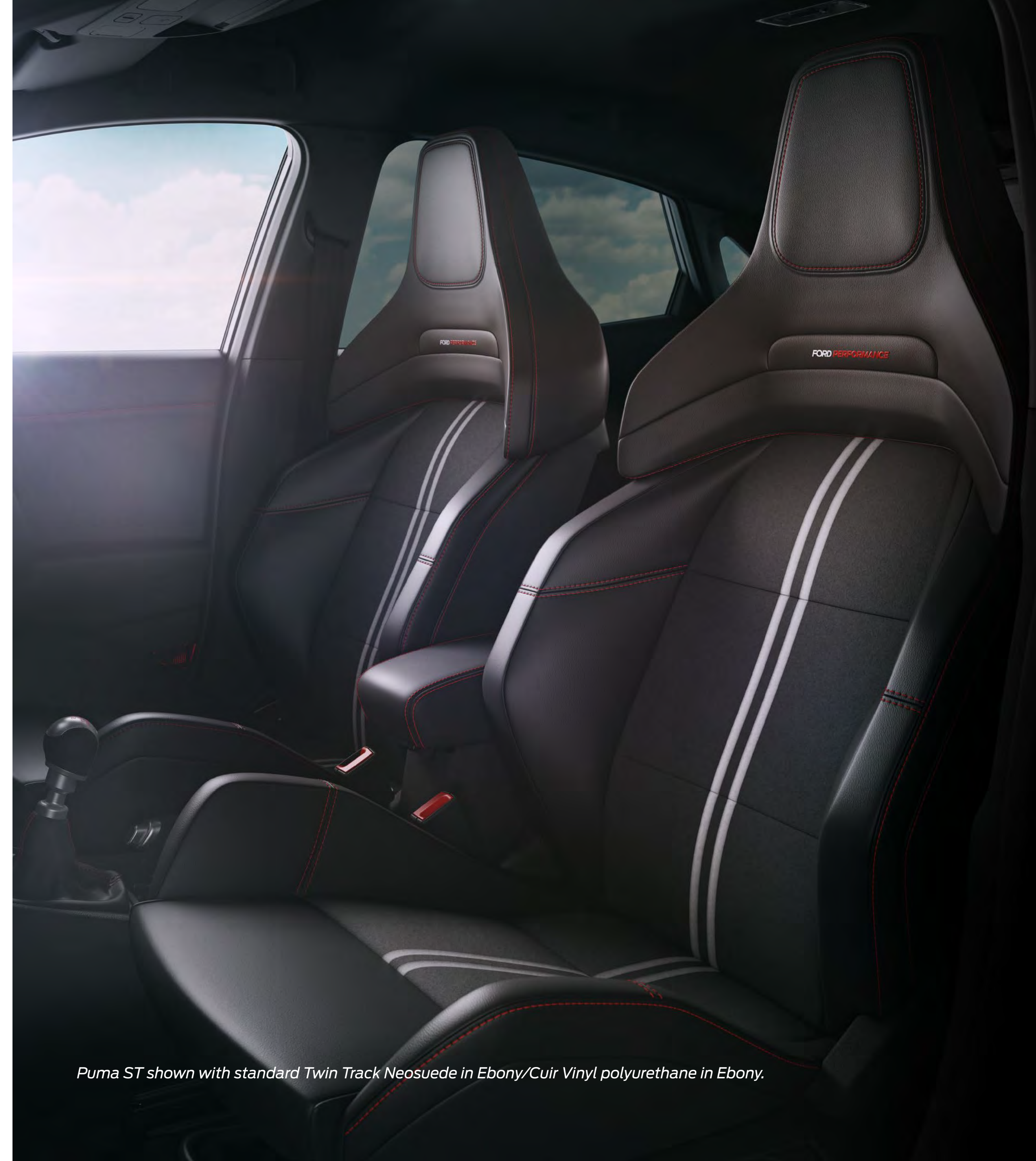
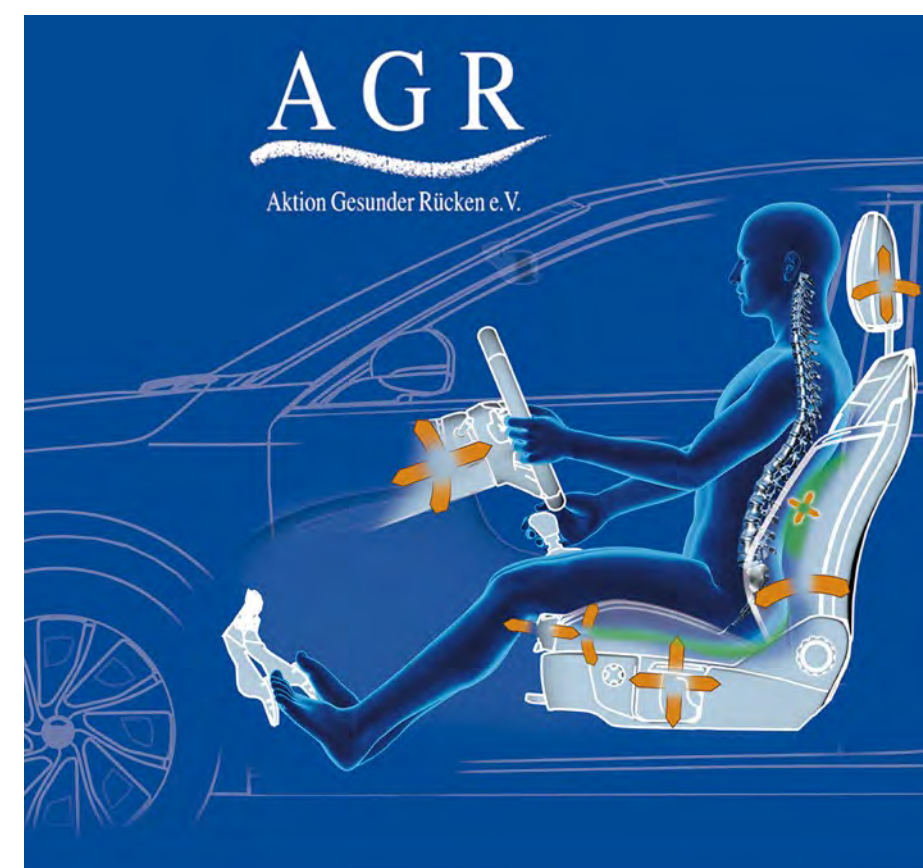

Puma ST shown with standard Twin Track Neosuede in Ebony/Cuir Vinyl polyurethane in Ebony.





## 1 EXPLORE

# VIEW LIFE DIFFERENTLY

## GO YOUR OWN WAY

Whichever series Puma you choose, you'll find it already comes with an extensive list of standard specifications. Now you add even more refined style with your choice of exclusive interior and exterior features, such as:

- **19" 5-spoke Matt Black machined finish alloy wheels** (option on ST-Line, ST-Line X and ST-Line Vignale)
- **Panorama roof** with power-operated tilt/slide opening and retractable sunshade (option)
- **Black roof rails** (option)
- **Heated steering wheel** (optional as part of the Winter Pack)

*Puma ST-Line X shown in Solar Silver premium body colour (optional) with 19" 5-spoke Matt Black machined alloy wheels (optional).*



# 1 EXPLORE



## CONNECTED AND IN CONTROL

### FORD SYNC 3

Available Ford SYNC 3 integrates seamlessly with your smartphone to make communication and navigation effortless\*. You can control SYNC-compatible apps with AppLink, while Apple CarPlay and Android Auto let you use the 8" colour touchscreen as if it were your smartphone handset. Using the touchscreen or simple voice commands, you can make calls, write and listen to text messages, and control your music and satellite navigation.

### FORDPASS CONNECT

FordPass Connect in all our Pumas enables a range of features designed to make driving easier and more enjoyable\*\*. These include Live Traffic† that delivers up-to-date traffic information to your SYNC 3 Navigation system, and Local Hazard Information†† that can warn you of upcoming hazards before they are encountered. In the event of an accident, eCall‡ helps occupants place a call with the emergency services and shares your location.

**Please note:** Full SYNC 3 smartphone integration is only available with iPhone 5/Android 5.0 (Lollipop) or higher. 100% connected. Only AppLink would incur charges. To check whether Apple CarPlay and Android Auto are available in your market, please refer to official Apple CarPlay and Android Auto websites for the latest information. Map updates are complimentary for a limited time following vehicle registration.

\*Don't drive while distracted. Use voice-operated systems when possible; don't use handheld devices while driving. Some features may be locked out while the vehicle is in gear. Not all features are compatible with all phones.

\*\*FordPass Connect enables connected services and is available on selected vehicles or vehicles with navigation. FordPass Connect will be enabled at time of vehicle delivery. You may choose to opt in/out of certain data sharing. Data coverage and service is not available everywhere. Data rates may be incurred. FordPass and Connected Car Privacy Policies apply, available on your local Ford website.

†Live Traffic access is complimentary for the first 12 months following the registration of a new Ford featuring SYNC 3 with navigation; thereafter a licence subscription is required.

††Local Hazard Information is complimentary for the first 12 months following the purchase of a new Ford with certain driver information modules; thereafter a licence subscription is required.

‡Ford eCall shares vehicle location and helps the occupants initiate a call in their respective language to the local Communications Centre, following a vehicle crash event involving an airbag deployment or fuel pump shut off. The feature operates in more than 40 European countries and regions.







## 1 EXPLORE

### FORDPASS APP

Get the most from your connected car experience with the FordPass app<sup>®</sup>. From smart remote features to detailed vehicle health reports, the FordPass app lets you access even more functions via your smartphone. For peace of mind, you can lock or unlock your vehicle wherever you are, and even defrost the windscreen and activate the heated seats and heated steering wheel (where fitted) on a cold winter's morning (models with automatic transmission only).

Health Alerts send important information, such as tyre pressure and fuel level warnings, direct to your phone.

Other FordPass app features include My Journeys, that can record your trips and deliver tailored insights on how to optimise your driving technique. Each journey is tracked and stored, allowing you to compare by distance, duration, and more.

FordPass also helps with security; you'll receive a notification if your car's alarm is activated, no matter where you are. The SecuriAlert feature takes security a step further and alerts you on your smartphone of any unauthorised access attempts – even with a stolen or duplicate key.

**Connect your Puma to FordPass.**

**Please note:** Full SYNC 3 smartphone integration is only available with iPhone 5/Android 5.0 (Lollipop) or higher. 100% connected. Only AppLink would incur charges. To check whether Apple CarPlay and Android Auto are available in your market, please refer to official Apple CarPlay and Android Auto websites for the latest information. Map updates are complimentary for a limited time following vehicle registration.

Remote start only available on models with automatic transmission.

<sup>®</sup>FordPass app, compatible with select smartphone platforms, is available via a download. Message and data rates may apply.

| SYNC

 FordPass



# 1 EXPLORE

## INTELLIGENT ADAPTIVE CRUISE CONTROL WITH EVASIVE STEERING ASSIST

Adaptive Cruise Control<sup>(02)</sup> maintains a set distance between you and the vehicle in front, and can bring your car to a stop. The Pre-Collision Assist<sup>(02)\*</sup>, with Evasive Steering Assist<sup>(02)\*\*</sup>, alerts you to potential hazards (such as vehicles and pedestrians), and is designed to help steer around obstacles, while applying the brakes to help reduce an impact (option available on all series except ST).



## SELECTABLE DRIVE MODES

Tailor your Puma driving experience to suit the conditions through a selection of five available drive modes. Prioritise different configurations of performance, power and economy, by selecting between **Normal, Sport, Trail, Slippery** and **Eco** settings.

The system adjusts various settings, including throttle response and steering feel, as well as gear-change behaviour on cars with automatic transmission. The instrument cluster also changes to reflect your chosen setting, and includes a 'quiet' mode that displays only the most important information.

<sup>0</sup>Uses sensors. <sup>2</sup>Driver Assistance feature. \*Pre-Collision Assist with Pedestrian Detection can detect pedestrians, but not in all conditions and does not replace safe driving. See owner's manual for system limitations. \*\*Evasive Steering Assist does not control steering.

**Note** Adaptive Cruise Control with Stop & Go (option on models with automatic transmission): If stop is longer than three seconds, driver must intervene and press "RES" button or accelerator pedal to resume system operation.

**Note** Driver-assist features are supplemental and do not replace the driver's attention, judgement and need to control the vehicle.



# 1 EXPLORE

## BLIND SPOT INFORMATION SYSTEM<sup>02)</sup>

Blind Spot Information System alerts you via discreet warning lights built into both door mirrors, when another vehicle – car, van or lorry – enters your blind spot while driving. Similarly, Cross Traffic Alert is designed to warn you if a moving vehicle or other hazard is detected, while you reverse from a perpendicular parking space, and can automatically apply the brakes if you take insufficient action (available on all series as part of the optional Driver Assistance Pack).

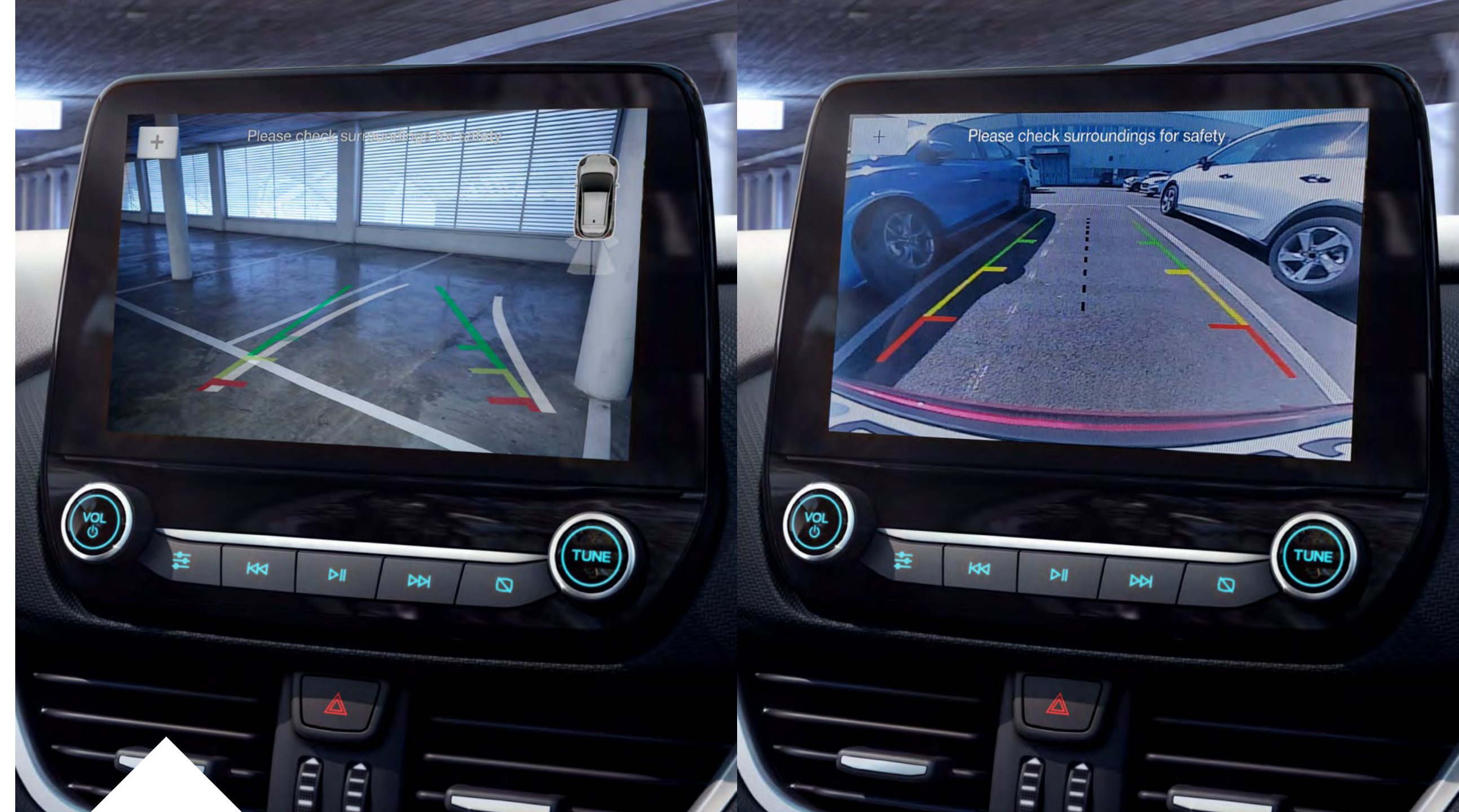

## REAR WIDE-VIEW CAMERA<sup>2)</sup>

Helpful when reversing into or out of spaces, and activated by selecting reverse gear, the rear wide-view camera provides a clear view left and right, displaying a near 180-degree view behind the car to your SYNC 3 screen (available on all series as part of the optional Driver Assistance Pack).

<sup>0)</sup>Uses sensors. <sup>2)</sup>Driver Assistance feature.

**Note** Driver-assist features are supplemental and do not replace the driver's attention, judgement and need to control the vehicle. Cameras only operate at speeds under 6 mph (10 km/h).



# 1 EXPLORE

## PRE-COLLISION ASSIST<sup>02)</sup>

Pre-Collision Assist with pedestrian detection monitors your proximity to other vehicles and pedestrians – even in the dark. If a potential collision is detected, it can alert you with visible and audible warnings and, if needed, pre-charge the brakes to increase brake sensitivity to help enhance responsiveness when you brake (standard on all series).



## PUMA PROJECTION PUDDLE LIGHTS

Be assured of a warm welcome with Puma's distinctive puddle lights. Each time you unlock the doors, puddle lights in the door mirrors illuminate the ground with the eye-catching Puma logo (standard on ST-Line Vignale) and Puma ST specific logo (standard on ST).

<sup>0)</sup>Uses sensors. <sup>2)</sup>Driver Assistance feature.

Pedestrian Detection is designed to operate at vehicle speeds of up to 50 mph (80 km/h). Pre-Collision Assist with Pedestrian Detection can detect pedestrians, but not in all conditions and does not replace safe driving. See owner's manual for system limitations.

**Note** Driver-assist features are supplemental and do not replace the driver's attention, judgement and need to control the vehicle.

## LED HEADLIGHTS<sup>0)</sup>

Efficient and long-lasting LED headlights produce a bright natural light with a very precise pattern. They also sense when it is dark (standard on ST-Line Vignale and ST, available as an option on ST-Line X).

Auto high beam detects oncoming vehicles and will automatically dip your beams for you. Available as standard on all series in conjunction with Lane-Keeping Aid (part of Lane-Keeping System).





# 1 EXPLORE

## PANORAMA ROOF

Enjoy more of the surrounding scenery from the comfort of your Puma. An electrically-operated panorama roof truly lets you bring the world outside into the vehicle cabin. Providing an abundance of fresh air when opened, the sliding glass also has a solar reflective coating to help keep the interior cool when closed. While an internal sunblind provides extra shade when you need it (option on all series).



## WIRELESS CHARGING PAD

A convenient wireless charging pad keeps your devices\* ready for use (standard on ST-Line X, ST-Line Vignale and ST).

\*Many devices, such as phones are able to charge wirelessly. To be compatible your phone will need to have Qi or you will need to have a Qi charging case.

## LUMBAR MASSAGE SEATS

Puma's driver and front passenger seats can be enhanced by a lumbar massage function for additional comfort and support. Activated at the push of a button, the 3-way adjustable massage settings revitalise tired muscles – ideal for longer journeys (standard on ST-Line Vignale only).





# 2 SELECT

With a choice of exterior and interior styling, there's a new Ford Puma that's right for you.

## SERIES OVERVIEW



### Titanium

The luxurious Titanium series delivers superior levels of sophistication and comfort using premium materials.



### ST-Line and ST-Line X

With its eye-catching individuality, ST-Line provides a captivating approach to our state-of-the-art sport series.



### ST-Line Vignale

Elevated levels of style and performance come together beautifully in the exceptional ST-Line Vignale.



### ST

Puma ST is both practical and refined with head-turning style, and delivers genuine hothatchback thrills.



## 2 SELECT

# TITANIUM

### Key exterior features

- 17" 10-spoke alloy wheel – Absolute Black machined
- Projector headlamps with LED day time running lamps
- Front fog lamps with cornering lights
- Rear LED lamps
- Auto headlights with rain-sensing wipers and auto high beam
- Power-foldable heated door mirrors with puddle lamps
- Rear parking sensors
- Quickclear heated windscreen

### Key interior features

- Ford SYNC 3 Navigation with 8" touchscreen and FordPass Connect (Embedded Modem)
- Electronic Automatic Temperature Control (EATC)
- Pre-collision assist with autonomous emergency braking (AEB)
- Cruise control
- Lane-keeping system and lane departure warning
- Auto-dimming rear-view mirror
- 4.2" colour TFT high series analogue cluster
- Ford MegaBox (Extended

boot space)

- Selectable drive modes (Normal, Eco, Sport, Slippery & Trail)

### Engines

#### Petrol mild hybrid

- 1.0L EcoBoost (mHEV) 125 PS 6-speed manual
- 1.0L EcoBoost (mHEV) 125 PS 7-speed automatic
- 1.0L EcoBoost (mHEV) 155 PS 6-speed manual

## SERIES

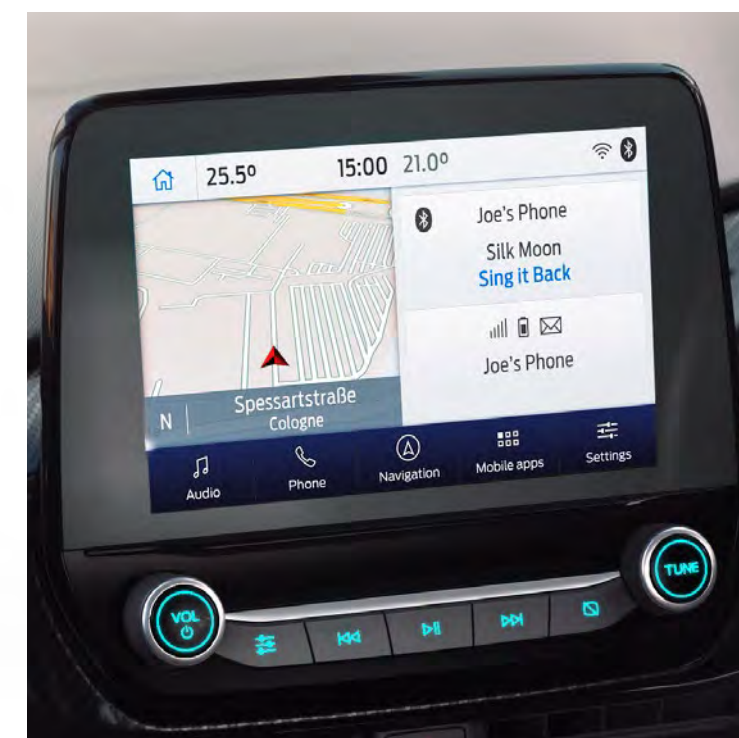



## 2 SELECT

# ST-LINE

### Key exterior features (different to Titanium)

- 17" 5x2-spoke alloy wheels – Black machined finish
- Unique ST-Line body colour front bumper and body colour rear bumper with diffuser
- Sports suspension
- Large rear spoiler
- ST-Line badge
- Chrome exhaust

### Key interior features (different to Titanium)

- 12.3" full digital instrument cluster
- Manual air conditioning
- ST-Line flat-bottomed leather steering wheel with unique red stitching
- Black leather-trimmed handbrake handle with red stitching
- Aluminium gearshift knob
- Sports-style front seats including 4-way manual seat adjustment with manual lumbar support
- Dark headliner

### Engines

#### Petrol mild hybrid vehicle

- 1.0L EcoBoost (mHEV) 125 PS 6-speed manual
- 1.0L EcoBoost (mHEV) 125 PS 7-speed automatic
- 1.0L EcoBoost (mHEV) 155 PS 6-speed manual

## SERIES

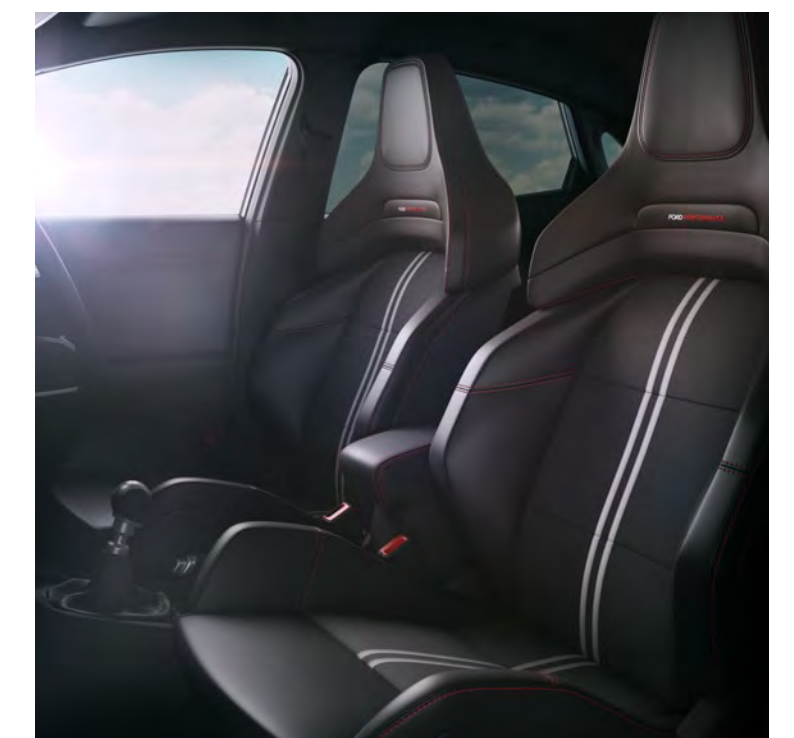



## 2 SELECT

# ST-LINE X

### Key exterior features in addition to ST-Line

- 18" 5x2-spoke Matt Black alloy wheels
- Privacy glass

### Key interior features in addition to ST-Line

- Partial Premium Sensico® man-made leather seat trim
- Electronic Automatic Temperature Control (EATC)
- B&O Premium Audio System (675 Watts, 10 Speakers)
- Wireless charging pad
- Carbon look interior deco spears

### Engines

#### Petrol mild hybrid vehicle

- 1.0L EcoBoost (mHEV) 125 PS 6-speed manual
- 1.0L Ford EcoBoost (mHEV) 125 PS 7-speed automatic
- 1.0L EcoBoost (mHEV) 155 PS 6-speed manual

## SERIES

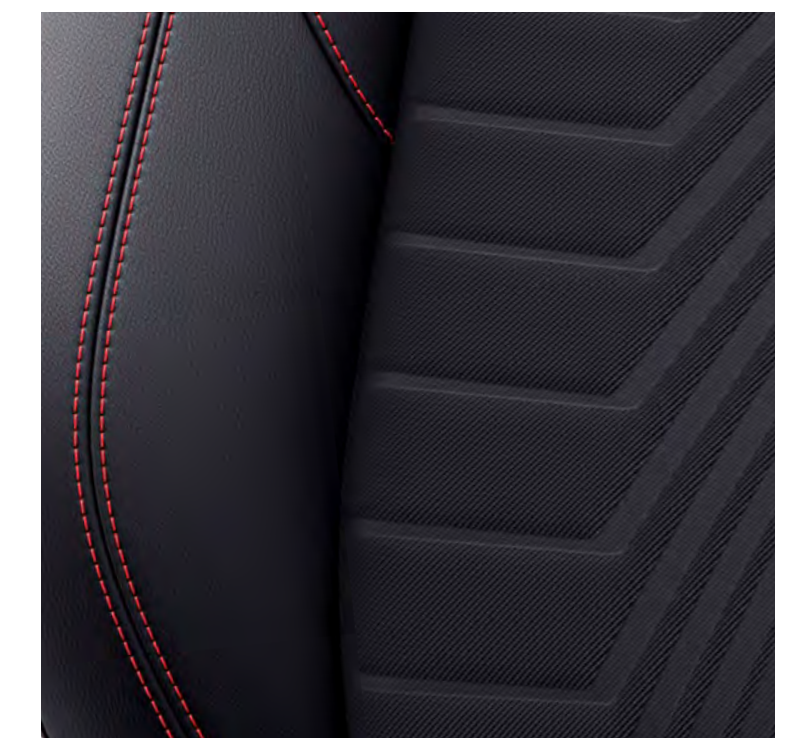
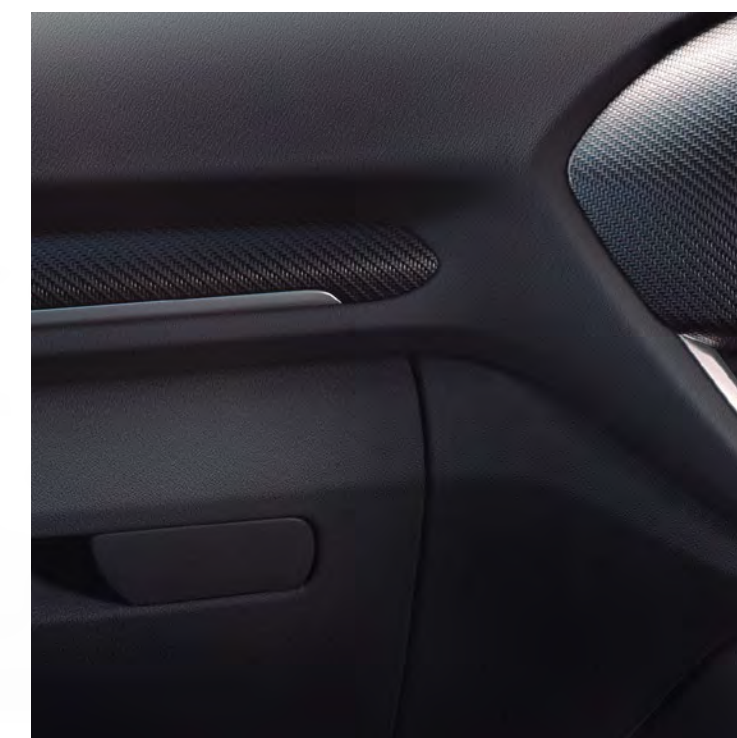



## 2 SELECT

## SERIES

# ST-LINE VIGNALE

### Key exterior features (additional to ST-Line X)

- 18" 10-spoke Absolute Black machined alloy wheels
- Unique Vignale exterior styling under alloy wheels
- Front parking sensors
- Fixed LED signature headlamps
- Dual power-foldable heated door mirror with floor logo lamp

### Key interior features (additional to ST-Line X)

- Premium Sensico® with metal grey stitching seat trim
- Sensico® wrapped unique instrument panel with Metal Grey stitching
- Heated driver/passenger seats
- Heated steering wheel
- Lumbar Massage Seats Driver and Passenger
- Keyless entry

### Engines

#### Petrol mild hybrid vehicle

- 1.0L EcoBoost (mHEV) 125 PS 6-speed manual
- 1.0L Ford EcoBoost (mHEV) 155 PS 7-speed automatic
- 1.0L EcoBoost (mHEV) 155 PS 6-speed manual





## 2 SELECT

## ST

### Key exterior features (additional to ST-Line X)

- 19" 5x2 spoke Magnetite machined alloy wheels
- Unique ST elements to front and rear body styling kit
- Ford Performance embossed splitter
- Fixed LED signature headlamps
- Black painted contrast roof
- Dual chrome exhaust
- Red brake calipers
- ST logo projection (from door mirrors)
- Front parking sensors

### Key interior features (additional to ST-Line X)

- ST flat bottomed steering wheel with metal grey stitching
- Recaro sport seats with ST logo finished in partial leather and Miko Dinamica
- Heated steering wheel and front heated seats
- Ford KeyFree System
- Unique ST gearshift knob
- ST scuff plates
- ST front and rear mats
- Alloy sports pedals
- Engine Sound Enhancer

### Engine

#### Petrol

1.5L Ford EcoBoost 200 PS  
6-speed manual

## SERIES





# 3 PERSONALISE

## COLOURS

Choose your colour, wheels, options and extras, and make Puma unmistakably yours.

Ford Puma owes its beautiful and durable exterior to a special multi-stage painting process. From the wax-injected steel body sections to the protective top coat, new materials and application processes ensure your new Puma will retain its good looks for many years to come.



**Mean Green<sup>†</sup>**  
ST exclusive body colour\*



**Blazer Blue**  
Standard



**Agate Black**  
Premium\*



**Solar Silver**  
Premium\*



**Frozen White**  
Premium\*



**Desert Island Blue**  
Exclusive\*



**Fantastic Red**  
Exclusive\*



**Grey Matter**  
Exclusive\*



**Magnetic**  
Exclusive\*

\*At extra cost.

<sup>†</sup>Body colour available for Puma ST only.

The Ford Puma is covered by the Ford Perforation Warranty for 12 years from the date of first registration. Subject to terms and conditions.

**Note:** The car images used are to illustrate body colours only and may not reflect current specification or product availability in certain markets. Colours and trims reproduced within this brochure may vary from the actual colours, due to the limitations of the printing processes used.





**Cloth trim in black**  
Standard for Titanium



**Cloth trim in black with red stitching**  
Standard for ST-Line



**Partial Sensico® trim with black cloth and red stitching**  
Standard on ST-Line X



**Premium Sensico® trim with metal grey stitching**  
Standard for ST-Line Vignale



**Ford Performance Seats in Partial Sensico® with grey metal stitching**  
Standard for ST

**Note** Sensico® is a Ford EU trademark for premium synthetic upholstery developed for automotive interiors. As a vegan upholstery, it combines a premium, soft feel, is durable and looks great. Maintenance friendly it is easy to clean and protected against stains and odour. With a high-quality appearance Sensico® feels not only great sitting on during a long journey but gives also a good conscience since it is not animal based. It is the peace of mind design for modern, aspiring car drivers.





**17"**  
10-spoke Black machined finish alloy wheel  
Standard on Titanium



**17"**  
5x2-spoke Black machined finish alloy wheel  
Standard on ST-Line



**18"**  
5x2-spoke Absolute Black alloy wheel  
Standard on ST-Line X



**18"**  
10-spoke Absolute Black machined alloy wheel  
Standard on ST-Line Vignale



**19"**  
5-spoke Matt Black machined alloy wheel  
Option on ST-Line, ST-Line X and ST-Line Vignale



**19"**  
5x2-spoke Magnetite machined alloy wheel  
Standard on ST



**19"**  
5x2-spoke Magnetite alloy wheel  
Option on ST



### 3 PERSONALISE

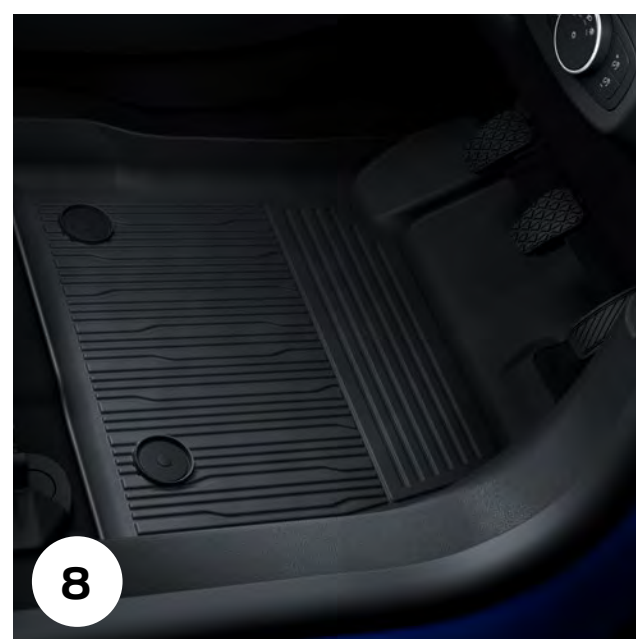
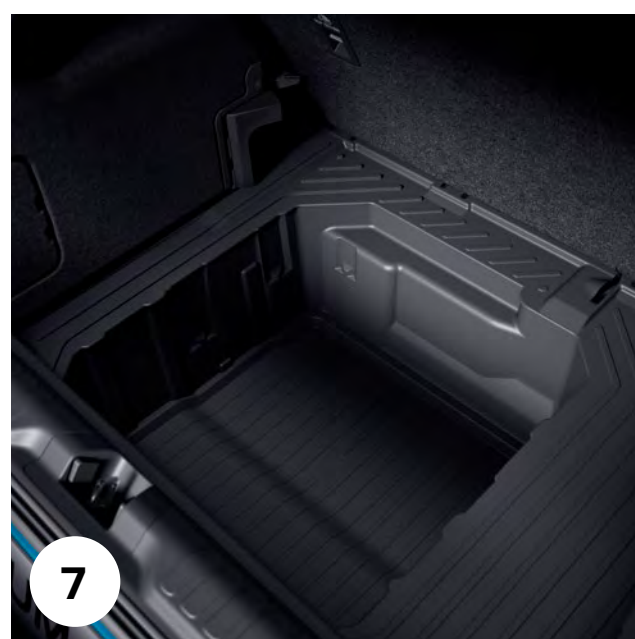
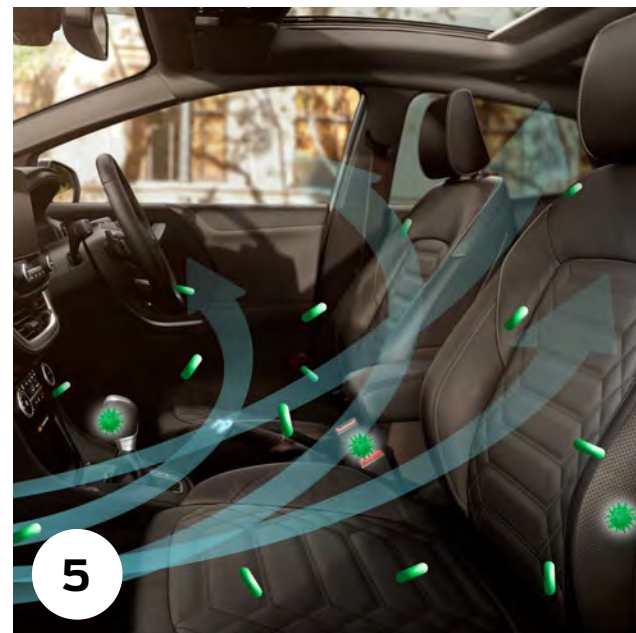

### ACCESSORIES

- 1 Rear bumper protection foil
- 2 4pets®+ caree transport box
- 3 Door sill protection foil
- 4 Coat hanger
- 5 Air purifier
- 6 Box-in-box system
- 7 MegaBox boot liner
- 8 Rubber floor mats
- 9 Boot liner
- 10 Cross bars
- 11 Thule®+ roof bike carrier
- 12 Mud flaps

Items ordered as an option, will be fitted in the factory. If ordered as an accessory, items will be fitted at the dealership. Fitment of accessories may have an impact on your vehicle's fuel consumption. +Item covered by third party supplier's warranty, please see back cover for details.

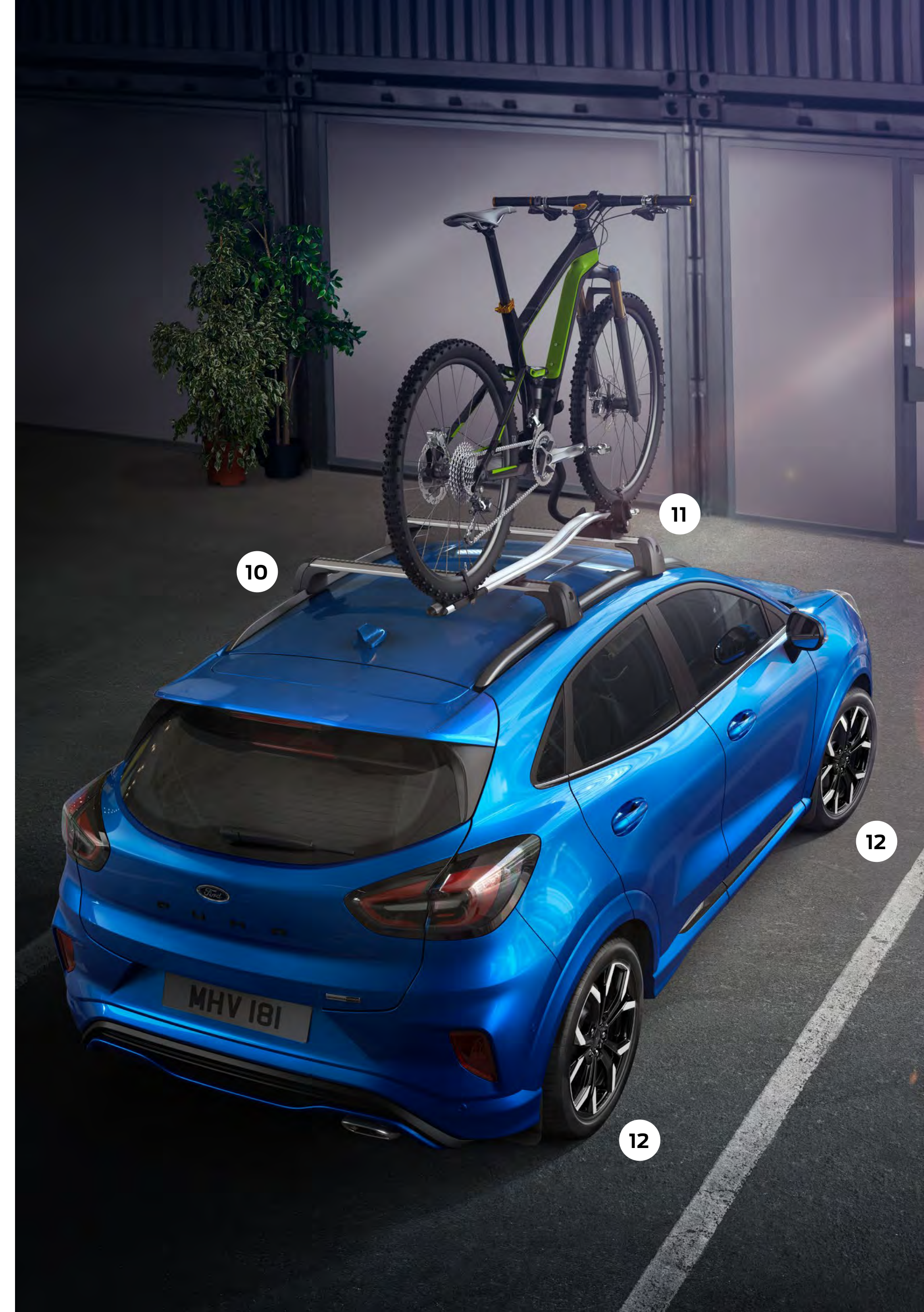

For more Puma accessories visit [www.ford-accessories.co.uk](http://www.ford-accessories.co.uk)

For a range of Ford branded merchandise – from clothing to lifestyle and travel products – visit [www.fordlifestylecollection.com](http://www.fordlifestylecollection.com)



# 4 SPECIFICATIONS

## POWER

Get to know your new Ford Puma inside and out, from its intelligent engine technology to its versatile loadspace.

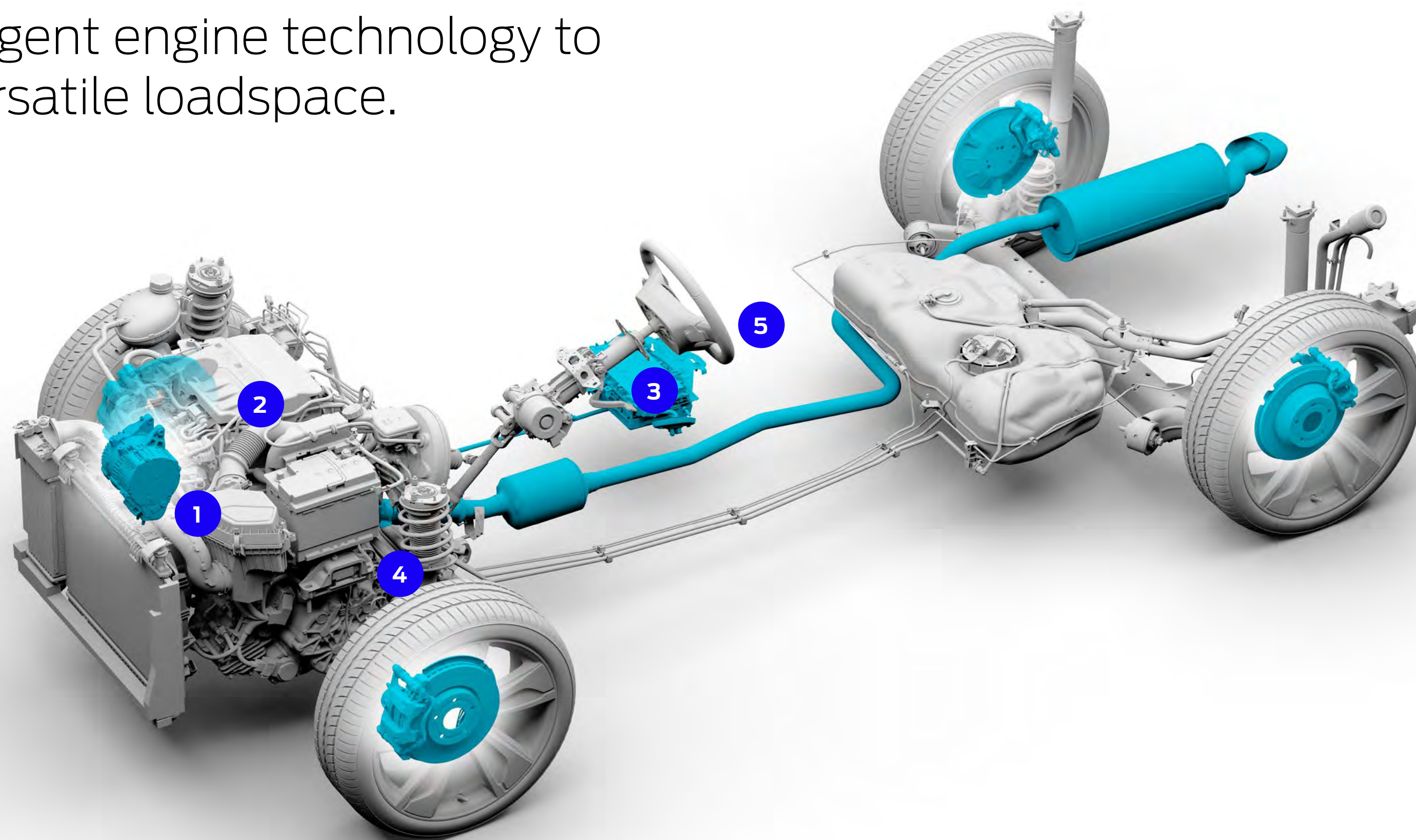

### PUMA ECOBOOST HYBRID

Available with a choice of 125 PS (92 kW) or 155 PS (114 kW) Ford EcoBoost Hybrid engines.

- 1 Belt-driven integrated starter/generator (BISG)**  
The BISG acts as an electric motor, seamlessly integrating with the petrol engine to provide additional torque during normal driving and accelerating.
- 2 1.0L Ford EcoBoost petrol engine**  
The Puma EcoBoost Hybrid is available with a choice of either a 125 PS (92 kW) or 155 PS (116 kW) Ford EcoBoost petrol engine.
- 3 48-volt battery**  
The lithium-ion battery that powers the electric motor is located under the front passenger seat. It is automatically recharged by the engine while you drive, and by regenerative braking that reclaims the energy typically wasted as you slow down.
- 4 Automatic transmission**  
Puma EcoBoost Hybrid's available 7-speed dual-clutch automatic transmission delivers seamless acceleration with smooth gearchanges. (Option on petrol and hybrid models)
- 5 Paddle Shifters**  
The 7-speed automatic transmission offers manual gear selection using sporty Paddle Shifters for ST-Line, ST-Line X and ST-Line Vignale.

**Note** For further fuel efficiency and emissions information, see Section 4, fuel and performance.



## STRIKING A BALANCE

### MILD HYBRID GIVES YOU MORE

With a choice of new forward-thinking, advanced mild hybrid (mHEV) petrol engines, the new Puma delivers outstanding performance, together with impressive fuel economy and low emissions figures

Ford's sophisticated mild hybrid technology is tailored to enhance fuel efficiency, while complementing Puma's acclaimed driving dynamics.

The system enhances the 1.0-litre Ford EcoBoost petrol engine with a belt-driven integrated starter/generator (BISG), which recovers the energy usually lost during braking and coasting, and uses it to charge its on-board battery pack.

The BISG also acts as a motor, seamlessly integrating with the petrol engine and using the stored energy to provide extra torque during driving and acceleration, as well as powering the vehicle's electrical systems to further enhance efficiency and performance.

\*6-speed manual.  
\*\*7-speed automatic.

### DYNAMIC

#### 1.0L Ford EcoBoost Hybrid (125 PS)\*

Enjoy outstanding fuel efficiency of up to 52.3 mpg (combined), and entertaining performance on motorways and country roads.



**125 PS (92 kW) – 210 Nm**  
From 123 g/km CO<sub>2</sub> emissions  
WLTP

**0-62 mph – 9.8 (secs)**

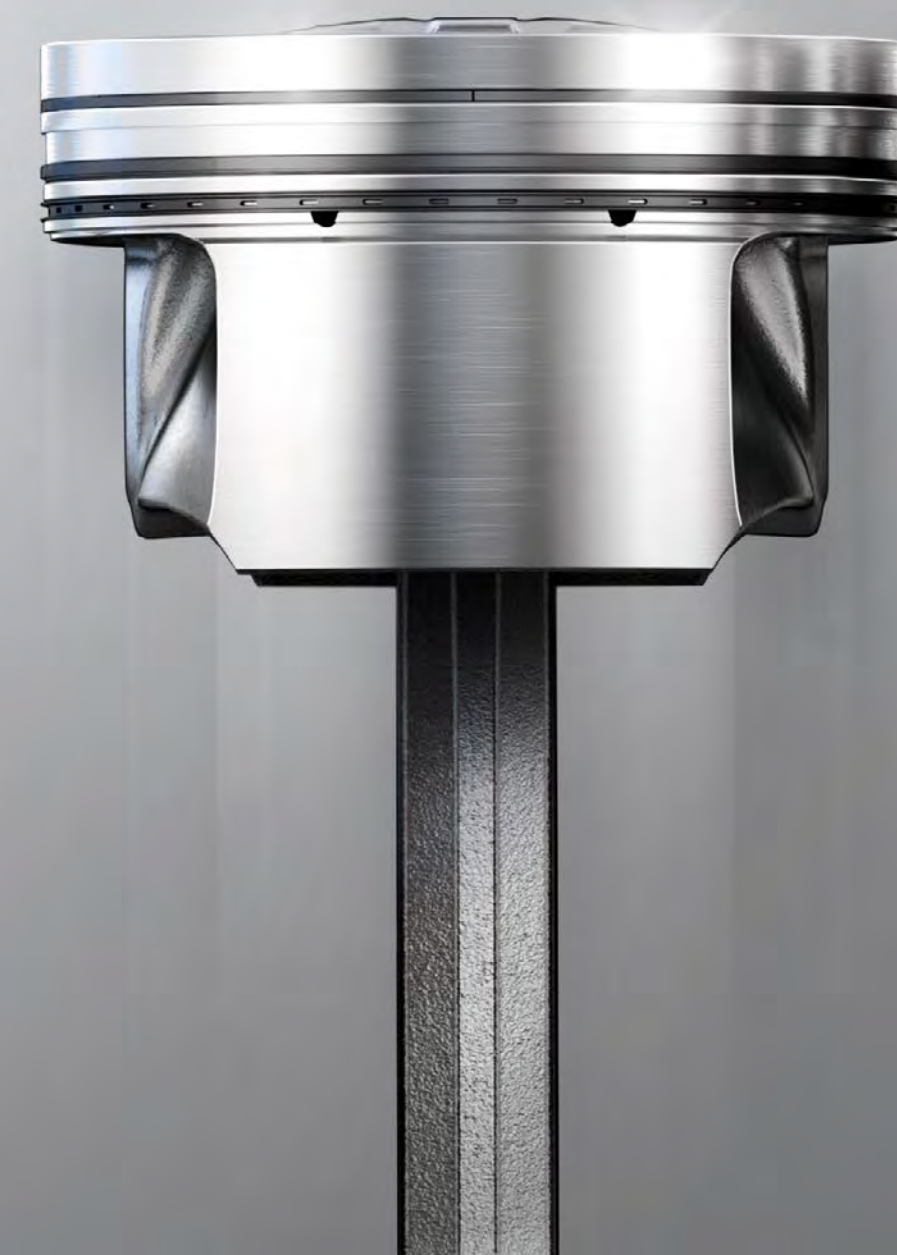

### PERFORMANCE

#### 1.0L Ford EcoBoost Hybrid (155 PS)\*\*

Striking a balance between delivering extra power while offering up to 51.4 mpg (combined).



**155 PS (116 kW) – 240 Nm**  
From 127 g/km CO<sub>2</sub> emissions  
WLTP

**0-62 mph – 8.7 (secs)**





# 4 SPECIFICATIONS

## FUEL AND PERFORMANCE

	1.0L EcoBoost Hybrid (125 PS)	1.0L EcoBoost Hybrid auto (125 PS)	1.0L EcoBoost Hybrid (155 PS)	1.0L EcoBoost Hybrid auto (155 PS)	1.5L EcoBoost (200 PS)
<b>5-DOOR</b>					
Emission standard	Stage 6.2	Stage 6.2	Stage 6.2	Stage 6.2	Stage 6.2
Maximum Power PS (kW)	125 (92)	125 (92)	155 (114)	155 (114)	200 (147)
Torque Nm	210	210	240	240	320
CO <sub>2</sub> emissions WLTP (g/km) <sup>99</sup>	122-124	130-131	124-126	128-130	148
Transmission	6-speed manual	7-speed automatic	6-speed manual	7-speed automatic	6-speed manual
Drive	4x2	4x2	4x2	4x2	4x2
<b>COMBINED FUEL CONSUMPTION (WLTP FIGURES WITH OPTIONS)<sup>99</sup></b>					
Lowest Performing MPG (L/100km) (Combined)	51.4 (5.5)	48.7 (5.8)	50.4 (5.6)	48.7 (5.8)	42.8 (6.6)
Highest Performing MPG (L/100km) (Combined)	52.3 (5.4)	49.6 (5.7)	51.4 (5.5)	49.6 (5.7)	42.8 (6.6)
<b>PERFORMANCE<sup>99</sup></b>					
Max. speed (mph)	119	118	124	124	137
0-62 mph (secs)	9.8	9.6	9.0	8.7	6.7
<b>WEIGHTS AND LOADS</b>					
Kerbweight (kg) <sup>#</sup>	1280	1334	1280	1334	1359
Gross vehicle mass (kg)	1765	1835	1765	1835	1815
Max. trailer mass 12% (kg)	1100	900	1100	900	750
Max. towable mass (kg) (unbraked)	640	640	665	665	675
Vertical load limit (kg) (tongue load)	75	75	75	75	75

\*In 4th gear. All petrol engines are equipped with a catalytic converter.

<sup>99</sup>The declared Fuel/Energy Consumptions, CO<sub>2</sub>-Emissions and Electric range are determined according to the technical requirements and specifications of the European Regulations (EC) 715/2007 and (EU) 2017/1151 as last amended. Light Duty Vehicles type-approved using the World Harmonised Light Vehicle Test Procedure (WLTP) have Fuel/Energy Consumptions and CO<sub>2</sub>-Emission information for both New European Drive Cycle (NEDC) and WLTP. WLTP is a new, more realistic test procedure for measuring fuel consumption and CO<sub>2</sub> emissions and has fully replaced the NEDC test. The applied standard test procedure enables comparison between different vehicle types and different manufacturers. In addition to the fuel efficiency of a car, driving behaviour as well as other non-technical factors play a role in determining a car's fuel/energy consumption, CO<sub>2</sub> emissions and electric range. CO<sub>2</sub> is the main greenhouse gas responsible for global warming. A guide on fuel economy and CO<sub>2</sub> emissions which contains data for all new passenger car models is available at any point of sale free of charge or can be downloaded under <http://carfueldata.dft.gov.uk>.

<sup>#</sup>Represents the lightest kerbweight assuming driver at 75 kg, full fluid levels and 90% fuel levels, subject to manufacturing tolerances and options, etc., fitted. **Towing limits** quoted represent the maximum towing ability of the vehicle at its gross vehicle mass to restart on a 12 per cent gradient at sea level. The performance and economy of all models will be reduced when used for towing. **Gross train mass** includes trailer weight. Roof load limit is a maximum of 50 kg on all models (roof load limit is reduced to 0 kg when panorama roof is specified). Towing capacity is reduced to 0 kg for 1.0 Ford EcoBoost engine when panorama roof is selected. Towing capacity is reduced to 0 kg for 1.0 Ford EcoBoost automatic when either a spare wheel or 18" alloys are selected. Towing limit is reduced to 0 kg for ST-Line series.



# 4 SPECIFICATIONS

## DIMENSIONS

	Titanium 5-door	ST-Line 5-door	ST 5-door
Overall length without/with towbar (mm)	4186	4207	4226
Overall width with mirrors (mm)	1930	1930	1930
Overall width with folded-back mirrors (mm)	1805	1805	1805
Overall height without roof rails (mm) (unladen)	1537	1537	1533
Minimum distance between wheel arches (mm) (in luggage compartment)	1000	1000	1000
Turning circle – kerb to kerb (m)	10.4	10.4	10.4
<b>INTERIOR DIMENSIONS</b>			
1st seat row headroom (mm) (without panorama roof)	1000	1000	1000
1st seat row leg room (mm) (maximum with seat in rearmost mid-height position)	1127	1127	1127
1st seat row shoulder room (mm)	1348	1348	1348
2nd seat row headroom (mm) (without panorama roof)	965	965	965
2nd seat row leg room (mm) (maximum with seat in rearmost mid-height position)	877	877	877
2nd seat row shoulder room (mm)	1320	1320	1320
<b>LUGGAGE CAPACITY (LITRES)</b>			
5-seat mode (laden to package tray, with tyre repair kit)	456	456	456
Ford MegaBox (with tyre repair kit)	80	80	80
2-seat mode (laden to roof) (with tyre repair kit)	1216	1216	1216
<b>LOADSPACE</b>			
Max. loading height (mm)	865	865	865
Loading width between wheel arches (mm)	1000	1000	1000
Loading length (at floor to second row seats) (mm)	726	726	726
<b>FUEL TANK CAPACITY (LITRES)</b>			
Petrol	42	42	45

Dimensions may vary dependent on the model and equipment fitted.

## DIMENSIONS



Height†: 1,537 mm

Length†: 4,207 mm



Width (with mirrors):  
1,930 mm



Width (without mirrors):  
1,805 mm

†Dimensions vary with ST series, Height 1,533 mm and Length 4,226 mm.



# 4 SPECIFICATIONS

## COLOUR AND TRIM

	Standard body colours	Premium body colours*			Exclusive body colours*				
	Blazer Blue	Frozen White	Agate Black	Solar Silver	Fantastic Red	Desert Island Blue	Grey Matter	Magnetic	Mean Green
<b>TITANIUM</b>									
Cloth trim in black	■	□	□	□	□	□	□	□	—
<b>ST-LINE</b>									
Cloth trim in black with red stitching	■	□	□	□	□	□	□	□	—
<b>ST-LINE X</b>									
Partial Premium Sensico with black cloth and red stitching	■	□	□	□	□	□	□	□	—
<b>ST-LINE VIGNALE</b>									
Premium Sensico with metal grey stitching	—	■	□	□	□	□	□	□	—
<b>ST</b>									
Partial Sensico with metal grey stitching	—	■	□	—	□	□	□	□	□

\*Premium and Exclusive body colours are options at extra cost.

■ Available as standard □ Available at extra cost — Not Available

## STYLING AND APPEARANCE

	Titanium	ST-Line	ST-Line X	ST-Line Vignale	ST
<b>WHEELS</b>					
Alloy – 17"x7", 10-spoke, Absolute Black finish (fitted with 215/55 R17 tyres*)	■	—	—	—	—
Alloy – 17"x7", 5x2-spoke, Black Machined Finish (fitted with 215/55 R17 tyres*)	—	■	—	—	—
Alloy – 18"x7", 5-spoke, Matt Black Machined Finish (fitted with 215/40 R18 tyres*)	—	—	■	—	—
Alloy – 18"x7", 5x2-spoke, ST-Line Vignale Unique Alloy (fitted with 215/40 R18 tyres*)	—	—	—	■	—
Alloy – 19"x7.5", 5-spoke, Matt Black Machined Finish (fitted with 225/40 R19 tyres*)	—	□	□	□	—
Alloy – 19"x7.5", 5-spoke, Magnetite Machined Finish (fitted with 225/40 R19 tyres*)	—	—	—	—	■
Alloy – 19"x7.5", 5-spoke, Magnetite Dark Finish (fitted with 225/40 R19 tyres*)	—	—	—	—	□
Tyre repair kit	■	■	■	■	■
Locking wheel nuts	■	■	■	■	■
<b>DESIGN FEATURES</b>					
Active grille shutter	■	■	■	■	—
Front bumper – Base facia body colour with lower part black	■	—	—	—	—
Front bumper – Unique ST-Line sport design, body colour	—	■	■	—	—
Front bumper – Unique ST-Line Vignale design, body colour	—	—	—	■	—
Front bumper – Unique ST design, body colour	—	—	—	—	■
Rear bumper – Plastic, dual colour	■	—	—	—	—
Rear bumper – Body colour with diffuser	—	■	■	—	—
Rear bumper – ST-Line Vignale Body colour with special masking	—	—	—	■	—
Rear bumper – ST unique	—	—	—	—	■
Bright exterior door frame moulding	—	—	—	■	—
Lower bodyside moulding with chrome insert	■	—	—	—	—
Lower bodyside moulding – Body colour	—	■	■	—	—

■ Standard □ Optional, at extra cost ■ Part of an option pack at extra cost — Not Available



# 4 SPECIFICATIONS

## STYLING AND APPEARANCE

	Titanium	ST-Line	ST-Line X	ST-Line Vignale	ST
Lower bodyside moulding – body coloured, high gloss black painted spear with chrome insert	—	—	—	■	—
Lower bodyside moulding – painted accents, painted door spears in high gloss black	—	—	—	—	■
Rear spoiler – Body colour with centre high mounted brake light	■	—	—	—	—
Large Rear spoiler – Body colour, with centre high mounted brake light	—	■	■	■	■
Tailgate – Manual	■	■	■	■	■
Ford KeyFree System with Ford Power starter button, includes Motion Sensing Key Fob (available as part of the optional Hands-free Power Tailgate)	□	□	□	■	■
Hands-free Power Tailgate	□	□	□	□	□
Rear Privacy Glass	□	□	■	■	■
ST-Line badge	—	■	■	■	—
Puma Badge	■	■	■	■	■
ST badge	—	—	—	—	■
EcoBoost Hybrid tailgate badge (only available with 1.0L EcoBoost Hybrid)	■	■	■	■	—
Roof Rails – Black	□	□	□	□	—
Threshold plates – Unique ST-Line, front	—	—	—	■	—
Threshold plates – Unique ST	—	—	—	—	■
Standard foot pedal design	■	■	■	■	■
Sport pedal design – Stainless steel cappings and rubber inserts	—	—	—	—	■
Headliner – Deluxe	■	■	■	■	■
Instrument panel – High level	■	■	■	■	■
<b>PAINT</b>					
Agate Black painted roof (only available with these body colours: Solar Silver, Magnetic, Desert Island Blue, Grey Matter and Fantastic Red)	□	□	□	□	■

\*The wheel you choose will be fitted with the tyre size noted, but no choice of tyre brand is available.

## DRIVING EXPERIENCE

	Titanium	ST-Line	ST-Line X	ST-Line Vignale	ST
<b>DRIVER ASSISTANCE</b>					
Active Park Assist – Front and rear parking distance sensors, including perpendicular park assist and park-out assist (available as part of the optional Parking Pack or Driver Assistance Pack)	■	■	■	■	■
Parking distance sensors – Rear	■	■	■	■	■
Parking distance sensors – Front (available as part of the optional Parking Pack or Driver Assistance Pack)	■	■	■	■	■
Cruise control (includes Adjustable Speed Limiter)	■	■	■	■	■
Adaptive Cruise Control (includes Evasive Steering Assist) (available as part of the optional Driver Assistance Pack)	■	■	■	■	■
Adaptive Cruise Control (includes Evasive Steering Assist and Stop and Go) (only available with 7-speed Automatic DCT transmission)	■	■	■	■	—
Selectable Drive Modes	■	■	■	■	■
Intelligent Speed Limiter	■	■	■	■	■
Rear wide-view camera (available as part of the optional Parking Pack or Driver Assistance Pack)	■	■	■	■	■
Lane-Keeping System with Lane Departure Warning	■	■	■	■	■
<b>EXTERIOR LIGHTING</b>					
Front fog lights (includes cornering lights)	■	■	■	■	■
Headlights – LED projector headlights (LED low beam projector included, LED daytime running lights, with either black bezel (ST-Line) or chrome bezel (Titanium))	■	■	■	—	—
Fixed LED signature headlamps	—	—	□	■	■
Headlights – Automatic on/off and high beam (includes automatic wipers with rain sensor, headlight courtesy delay and manual levelling)	■	■	■	■	■
Rear lights – Split LED	■	■	■	■	■
<b>SUSPENSION</b>					
Suspension – Standard duty	■	—	—	—	—
Suspension – Sports-tuned	—	■	■	■	—
Suspension – ST unique	—	—	—	—	■

■ Standard □ Optional, at extra cost ■ Part of an option pack at extra cost — Not Available



# 4 SPECIFICATIONS

## DRIVING EXPERIENCE

	Titanium	ST-Line	ST-Line X	ST-Line Vignale	ST
<b>INSTRUMENTS AND CONTROLS</b>					
Steering wheel – 3-spoke, Sensico-trimmed	■	—	—	—	—
Steering wheel – 3-spoke, Sensico-trimmed sport with unique stitching	—	■	■	■	—
Steering wheel – 3-spoke, Sensico-trimmed sport with ST unique stitching	—	—	—	—	■
Heated Steering wheel – (available as part of the optional Winter Pack)	□	□	□	■	■
<b>OPTION PACKS</b>					
Parking Pack - Active Park Assist, Front Parking Sensors, Rear View Camera (Parking Pack is included in the Driver Assistance Pack)	□	□	□	—	—
Driver Assistance Pack with parking - AEB by Radar/Camera, BLIS with CTA and Active Braking, Intelligent Adaptive Cruise Control (ACC) with Evasive Steering with manual transmission, ACC Stop and Go incl. Traffic Jam Assist (Automatic Only), Active Park Assist, Front Parking Sensors and Rear View Camera	□	□	□	—	—
Driver Assistance Pack with parking - AEB by Radar/Camera, BLIS with CTA and Active Braking, Intelligent Adaptive Cruise Control (ACC) with Evasive Steering with manual transmission, ACC Stop and Go incl. Traffic Jam Assist (Automatic Only), Active Park Assist, Front Parking Sensors and Rear View Camera	—	—	—	□	—
Driver Assistance Pack with parking - AEB by Radar/Camera, BLIS with CTA and Active Braking, Active Park Assist and Rear View Camera	—	—	—	—	□

## COMFORT AND CONVENIENCE

	Titanium	ST-Line	ST-Line X	ST-Line Vignale	ST
<b>INTERIOR CONVENIENCE</b>					
Openable panorama roof	□	□	□	□	□
Centre console – Premium, two front illuminated cup holders with armrest and openable stowage area with USB connectivity, and 12 V power point	■	■	■	■	■
<b>AUDIO AND COMMUNICATION SYSTEMS</b>					
Ford SYNC 3 Navigation with DAB, 8" TFT touchscreen display, seven speakers (four front, two rear, one centre), MP3-compatible, remote audio controls, Voice Control System, Apple CarPlay, Android Auto, Emergency Assistance*, hands-free calling, GPS, Bluetooth®, FordPass Connect, Privacy Mode, and two USB ports for external music devices	■	■	—	—	—
B&O Premium Audio System + Ford SYNC 3 Navigation, with DAB, 8" TFT touchscreen display, 10 speakers (four front, four rear, one centre) with subwoofer, MP3-compatible, remote audio controls, B&O Sound System, Voice Control System, Apple CarPlay, Android Auto, Emergency Assistance*, hands-free calling, GPS, Bluetooth®, FordPass Connect, Privacy Mode, and two USB ports for external music devices	—	—	■	■	■
<b>CLIMATE CONTROL</b>					
Air conditioning – Manual control	—	■	—	—	—
Air conditioning – Electronic Automatic Temperature Control (EATC) (available with the optional Wireless charging pad)	■	▣	■	■	■
<b>INTERIOR LIGHTING</b>					
Courtesy light – Ambient LED courtesy lighting (single colour), footwell area, cup holder, door map pockets, front and rear map-reading lights	■	■	■	■	■

\*Ford Emergency Assistance is an innovative SYNC feature that uses a Bluetooth®-paired and connected mobile phone to help vehicle occupants initiate a direct call to the local Communications Centre, following a vehicle collision event involving an airbag deployment or fuel pump shut off. The feature operates in more than 40 European countries and regions.

## PERFORMANCE AND EFFICIENCY

	Titanium	ST-Line	ST-Line X	ST-Line Vignale	ST
<b>ENGINE</b>					
Auto Start-Stop	■	■	■	■	■
<b>TECHNOLOGY</b>					
Trip/fuel computer	■	■	■	■	■

■ Standard □ Optional, at extra cost ▣ Part of an option pack at extra cost — Not Available



# 4 SPECIFICATIONS

## COMFORT AND CONVENIENCE

	Titanium	ST-Line	ST-Line X	ST-Line Vignale	ST
<b>SEATING</b>					
Front seats – Sports-style (including rear map pocket)	■	■	■	■	—
Front seats – Ford Performance seats	—	—	—	—	■
Front seat – Driver's manual height and fore/aft adjustment 4-way	■	■	■	■	■
Front seat – Driver's manual height and fore/aft adjustment 6-way	—	—	—	—	■
Front seat – Passenger's manual height and fore/aft adjustment 4-way (included with Panorama Roof option)	▣	▣	■	■	—
Front seat – Passenger's manual height and fore/aft adjustment 6-way	—	—	—	—	■
Front seat – Driver's manual lumbar support adjustment	■	■	■	—	—
Front seat – Driver massage seat lumbar support	—	—	—	■	—
Front seat – Driver's 4-way lumbar adjust	—	—	—	—	■
Front seat – Passenger's manual lumbar support adjustment	■	■	■	—	—
Front seat – Passenger massage seat lumbar support	—	—	—	■	—
Front seat – Passenger's 4-way lumbar adjust	—	—	—	—	■
Heated front seats (Available as part of the optional Winter Pack)	▣	▣	▣	■	■
Rear seats – 2-way head restraint up/down	■	■	■	■	■
Rear seats – 60:40 split folding seat back	■	■	■	■	■
<b>INSTRUMENTS AND CONTROLS</b>					
Door mirrors – Electrically-operated and heated, power-foldable, integrated side indicator, body colour housings	■	■	■	—	—
Door mirrors – Electrically-operated and heated, power-foldable, integrated side indicator, black colour housings with logo projection	—	—	—	■	■
Tailgate wash/wipe	■	■	■	■	■
Wipers – Automatic, with rain sensor	■	■	■	■	■
Handbrake – Black Sensico-trimmed with stitching	■	■	■	■	■
Gearshift knob – Sensico-trimmed with premium gaiter (red stitching for ST-Line and ST-Line X)(automatic transmission)	■	■	■	■	—
Gearshift knob – ST-Line and ST-Line X aluminium knob and gaiter (manual transmission)	—	■	■	—	—
Soft-feel gearshift knob with Metal Grey stitching	—	—	—	—	■

## COMFORT AND CONVENIENCE

	Titanium	ST-Line	ST-Line X	ST-Line Vignale	ST
<b>TECHNOLOGY</b>					
Soft-feel gearshift boot with Metal Grey stitching	■	—	—	■	—
Soft-feel gearshift boot with Red stitching	—	■	■	—	■
<b>TECHNOLOGY</b>					
Ford Power starter button	■	■	■	■	■
Ford KeyFree System with Ford Power starter button with Motion Sensing Key Fob	—	—	—	■	■
Windows – Electrically-operated front with one-touch lowering/closing on driver's side	■	■	■	■	■
Windows – Electrically-operated front and rear with one-touch lowering/closing on driver's side, global closing	■	■	■	■	■
<b>TECHNOLOGY</b>					
4.2" colour TFT high series analogue cluster	■	—	—	—	—
12.3" full colour TFT/LCD instrument cluster	□	■	■	■	■
Quickclear heated windscreen	■	■	■	■	■
Wireless charging pad (with Electronic Air Temperature Control (EATC) for ST-Line)	□	▣	■	■	■
Rear-view mirror – Auto-dimming and rain sensing	■	■	■	■	■

\*Ford Emergency Assistance is an innovative SYNC feature that uses a Bluetooth®-paired and connected mobile phone to help vehicle occupants initiate a direct call to the local Communications Centre, following a vehicle collision event involving an airbag deployment or fuel pump shut off. The feature operates in more than 40 European countries and regions.

■ Standard □ Optional, at extra cost ▣ Part of an option pack at extra cost — Not Available



# 4 SPECIFICATIONS

## SAFETY AND SECURITY

	Titanium	ST-Line	ST-Line X	ST-Line Vignale	ST
<b>SAFETY</b>					
Blind Spot Information System with Cross Traffic Alert and trailer coverage (available as part of the optional Driver Assistance Pack)	<input checked="" type="checkbox"/>	<input checked="" type="checkbox"/>	<input checked="" type="checkbox"/>	<input checked="" type="checkbox"/>	<input checked="" type="checkbox"/>
Acoustic laminated windscreen	<input checked="" type="checkbox"/>	<input checked="" type="checkbox"/>	<input checked="" type="checkbox"/>	<input checked="" type="checkbox"/>	<input checked="" type="checkbox"/>
First aid kit strap	<input checked="" type="checkbox"/>	<input checked="" type="checkbox"/>	<input checked="" type="checkbox"/>	<input checked="" type="checkbox"/>	<input checked="" type="checkbox"/>
Restrain Device Pack – Includes Front, Side and Curtain driver and front passenger's airbags <sup>♦1)</sup> , belt minder and belt pretensioner (no pretensioner on rear centre seat), front and rear outer seats with load limiter, ISOFIX and top tether	<input checked="" type="checkbox"/>	<input checked="" type="checkbox"/>	<input checked="" type="checkbox"/>	<input checked="" type="checkbox"/>	<input checked="" type="checkbox"/>
<b>SECURITY</b>					
Remote central/double locking	<input checked="" type="checkbox"/>	<input checked="" type="checkbox"/>	<input checked="" type="checkbox"/>	<input checked="" type="checkbox"/>	<input checked="" type="checkbox"/>
Thatcham Category 1 perimeter and volume-sensing alarm	<input checked="" type="checkbox"/>	<input checked="" type="checkbox"/>	<input checked="" type="checkbox"/>	<input checked="" type="checkbox"/>	<input checked="" type="checkbox"/>
<b>BRAKES</b>					
Pre-Collision Assist with Emergency Brake Assist, Active Braking with Pedestrian Detection and Forward Alert	<input checked="" type="checkbox"/>	<input checked="" type="checkbox"/>	<input checked="" type="checkbox"/>	<input checked="" type="checkbox"/>	<input checked="" type="checkbox"/>
Electronic Stability Control <sup>1)</sup> with Traction Control <sup>1)</sup> and Emergency Brake Assist (EBA) <sup>1)</sup>	<input checked="" type="checkbox"/>	<input checked="" type="checkbox"/>	<input checked="" type="checkbox"/>	<input checked="" type="checkbox"/>	<input checked="" type="checkbox"/>
Emergency Brake Warning <sup>2)</sup> – Automatic flashing of brake lights under heavy braking	<input checked="" type="checkbox"/>	<input checked="" type="checkbox"/>	<input checked="" type="checkbox"/>	<input checked="" type="checkbox"/>	<input checked="" type="checkbox"/>
<b>INSTRUMENTS AND CONTROLS</b>					
Lane-Keeping Aid (includes Lane-Keeping Alert)	<input checked="" type="checkbox"/>	<input checked="" type="checkbox"/>	<input checked="" type="checkbox"/>	<input checked="" type="checkbox"/>	<input checked="" type="checkbox"/>
Cruise control (includes Adjustable Speed Limiter)	<input checked="" type="checkbox"/>	<input checked="" type="checkbox"/>	<input checked="" type="checkbox"/>	<input checked="" type="checkbox"/>	<input checked="" type="checkbox"/>
Intelligent Adaptive Cruise Control (ACC) with Evasive Steering with manual transmission (ACC is not available on ST), ACC Stop and Go incl. Traffic Jam Assist (Automatic Only) (available as part of the optional Driver Assistance Pack)	<input checked="" type="checkbox"/>	<input checked="" type="checkbox"/>	<input checked="" type="checkbox"/>	<input checked="" type="checkbox"/>	<input type="checkbox"/>
<b>TECHNOLOGY</b>					
Traction Control – Including Hill Start Assist <sup>2)</sup> , Anti-lock braking system (ABS), Emergency Brake Assist (EBA)	<input checked="" type="checkbox"/>	<input checked="" type="checkbox"/>	<input checked="" type="checkbox"/>	<input checked="" type="checkbox"/>	<input checked="" type="checkbox"/>
Tyre Pressure Monitoring System (TPMS) <sup>1)</sup>	<input checked="" type="checkbox"/>	<input checked="" type="checkbox"/>	<input checked="" type="checkbox"/>	<input checked="" type="checkbox"/>	<input checked="" type="checkbox"/>

♦Note: A child seat should never be placed in the front passenger seat when the Ford vehicle is equipped with an operational front passenger's airbag. The safest place for children is properly restrained on the rear seat.

## UTILITY

	Titanium	ST-Line	ST-Line X	ST-Line Vignale	ST
<b>CARPET AND TRIM</b>					
Front floor mats	<input checked="" type="checkbox"/>	<input checked="" type="checkbox"/>	<input checked="" type="checkbox"/>	<input type="checkbox"/>	<input type="checkbox"/>
Front and rear floor mats	<input type="checkbox"/>	<input type="checkbox"/>	<input type="checkbox"/>	<input checked="" type="checkbox"/>	<input type="checkbox"/>
Floor mats – ST	<input type="checkbox"/>	<input type="checkbox"/>	<input type="checkbox"/>	<input type="checkbox"/>	<input checked="" type="checkbox"/>
<b>EXTERIOR FUNCTIONAL</b>					
Detachable tow bar	<input type="checkbox"/>	<input type="checkbox"/>	<input type="checkbox"/>	<input type="checkbox"/>	<input type="checkbox"/>
<b>LOADSPACE COMPARTMENT</b>					
Load management system including Ford MegaBox	<input checked="" type="checkbox"/>	<input checked="" type="checkbox"/>	<input checked="" type="checkbox"/>	<input checked="" type="checkbox"/>	<input checked="" type="checkbox"/>

## FORD WARRANTY AND SERVICING PLANS

	Puma
<b>3-year/60,000 miles<sup>1)</sup> Ford Warranty</b>	
<input checked="" type="checkbox"/>	<input checked="" type="checkbox"/>
<b>1-year/unlimited mileage<sup>1)</sup> Ford Assistance Roadside Cover (Europe)</b>	
<input checked="" type="checkbox"/>	<input checked="" type="checkbox"/>
<b>2 or 4-year Ford Protect Service Plan, including scheduled servicing and extended Ford Assistance</b>	
<input type="checkbox"/>	<input type="checkbox"/>
<b>3-year/unlimited mileage<sup>1)</sup> Paint Warranty</b>	
<input checked="" type="checkbox"/>	<input checked="" type="checkbox"/>
<b>12-year/unlimited mileage<sup>1)</sup> Perforation Warranty</b>	
<input checked="" type="checkbox"/>	<input checked="" type="checkbox"/>

<sup>1)</sup>Whichever occurs soonest; from date of first registration. Year 1 - unlimited mileage. Subject to terms and conditions.

Standard  Optional, at extra cost  Part of an option pack at extra cost  Not Available



	Part Number	Series				
		Titanium	ST-Line	ST-Line X	ST-Line Vignale	ST
<b>TOW BARS</b>						
Detachable Tow Bar	2 457 405	↙	↙	↙	↙	↙
<b>REAR TRANSPORTATION</b>						
Uebler* Rear Bike Carrier I21	2 241 807	↙	↙	↙	↙	↙
Uebler* Rear Bike Carrier I21	2 331 137	↙	↙	↙	↙	↙
Uebler* Transport Bag	Various	↙	↙	↙	↙	↙
Mottez* Ski & Snowboard Carrier tow bar mounted	2 483 279	↙	↙	↙	↙	↙
<b>ROOF TRANSPORTATION</b>						
Thule®* Roof Ski Carrier SnowPack Extender 7325	2 318 742	↙	↙	↙	↙	↙
Thule®* Roof Ski Carrier SnowPack 7326	2 117 636	↙	↙	↙	↙	↙
Thule®* Roof Bike Carrier FreeRide 532	1 746 077	↙	↙	↙	↙	↙
Thule®* Roof Bike Carrier Expert 298	2 143 360	↙	↙	↙	↙	↙
Roof Base Carrier for vehicles without factory fitted roof rails	2 527 164	↙	↙	↙	↙	↙
Roof Cross Bars for vehicles with factory fitted roof rails	2 527 166	↙	↙	↙	↙	—
G3* Roof Box Elegance Europe 330 Premium, Glossy anthracite	2 371 147	↙	↙	↙	↙	↙
G3* Roof Box Elegance Europe 330, matt black	2 191 625	↙	↙	↙	↙	↙
Thule®* Roof Box Force XT S, Black Matte	2 430 262	↙	↙	↙	↙	↙
<b>INTERIOR TRANSPORTATION SYSTEMS</b>						
Umbrella Holder	1 524 823	↙	↙	↙	↙	↙
4pets®* Caree Transport Box For cats and dogs to be securely fixed onto most passenger seats, Cool Grey	2 460 886	↙	↙	↙	↙	↙
4pets®* Caree ISOFIX Attachment For Caree transport boxes	2 461 044	↙	↙	↙	↙	↙

Please note that this overview does not show the complete range of products available. For further accessories and more information please visit [www.shop.ford.co.uk](http://www.shop.ford.co.uk).  
\* The identified accessories are carefully selected third party supplier branded accessories and may have different warranty conditions, the details of which can be obtained from your Ford Dealer.

	Part Number	Series				
		Titanium	ST-Line	ST-Line X	ST-Line Vignale	ST
<b>LOAD COMPARTMENT ACCESSORIES</b>						
Boot Liner	2 438 719	↙	↙	↙	↙	↙
Load Compartment Mat	2 395 437	↙	↙	↙	↙	↙
Load Retention Guard	2 437 781	↙	↙	↙	↙	↙
Box-In-Box System for placement inside the Ford Puma MegaBox or as a stand-alone transport solution, black	2 469 549	↙	↙	↙	↙	↙
Foldable Transport Box black fabric, with white Ford oval on both sides	2 470 827	↙	↙	↙	↙	↙
Foldable Organizer Box black fabric, with white Ford oval on both sides	2 470 825	↙	↙	↙	↙	↙
padsforall®* Pet Travel Mat Black PU leather with blue piping, size: XS	2 500 385	↙	↙	↙	↙	↙

Please note that this overview does not show the complete range of products available. For further accessories and more information please visit [www.shop.ford.co.uk](http://www.shop.ford.co.uk).  
\* The identified accessories are carefully selected third party supplier branded accessories and may have different warranty conditions, the details of which can be obtained from your Ford Dealer.



## PROTECTION

	Part Number	Series				
		Titanium	ST-Line	ST-Line X	ST-Line Vignale	ST
<b>INTERIOR PROTECTION</b>						
Rubber Floor Mats	Various	Available	Available	Available	Available	Available
MegaBox Boot Liner	Various	Available	Available	Available	Available	Available
Velour Floor Mats	Various	Available	Available	Available	Available	Available
Door Sills Protection Foil rear, transparent	2 460 175	Available	Available	Available	Available	Not Available
<b>EXTERIOR PROTECTION</b>						
Premium Protective Cover indoor use, black with white liner and white Ford oval	2 458 163	Available	Available	Available	Available	Available
Mud Flaps	Various	Available	Available	Available	Available	Available
Rear Bumper Protector Foil, transparent	2 459 998	Available	Not Available	Not Available	Not Available	Not Available
RIVAL* Body Undershield for engine, aluminium	2 534 410	Available	Available	Available	Available	Available

Please note that this overview does not show the complete range of products available. For further accessories and more information please visit [www.shop.ford.co.uk](http://www.shop.ford.co.uk).

\*The identified accessories are carefully selected third party supplier branded accessories and may have different warranty conditions, the details of which can be obtained from your Ford Dealer.

## SAFETY & SECURITY

	Part Number	Series				
		Titanium	ST-Line	ST-Line X	ST-Line Vignale	ST
<b>ROADSIDE ASSISTANCE</b>						
Premium Safety Pack	2 311 429	Available	Available	Available	Available	Available
Life Safety Products* Window Cleaner with extendable handle	2 471 674	Available	Available	Available	Available	Available
Life Safety Products* Life Hammer automatic	2 471 504	Available	Available	Available	Available	Available
Kalff* Premium Safety Pack	Various	Available	Available	Available	Available	Available
<b>CHILD SAFETY</b>						
Britax Römer® Child Seat	2 474 787	Available	Available	Available	Available	Available

Please note that this overview does not show the complete range of products available. For further accessories and more information please visit [www.shop.ford.co.uk](http://www.shop.ford.co.uk).

\*The identified accessories are carefully selected third party supplier branded accessories and may have different warranty conditions, the details of which can be obtained from your Ford Dealer.



## COMFORT

	Part Number	Series				
		Titanium	ST-Line	ST-Line X	ST-Line Vignale	ST
<b>COMFORT PRODUCTS</b>						
Dashboard Camera for integration with SYNC 3	2 421 817	Available	Available	Available	Available	Available
NEXTBASE* Dashboard Camera 380GWX, front and rear	2 534 404	Available	Available	Available	Available	Available
ACV* Sleeping Headrest black PVC leather with silver piping	2 520 207	Available	Available	Available	Available	Available
Air Purifier	2 485 741	Available	Available	Available	Available	Available
Coat Hanger with docking unit, matt black	2 448 529	Available	Available	Available	Available	Available
ClimAir®* Wind Deflectors	Various	Available	Available	Available	Available	Available

Please note that this overview does not show the complete range of products available. For further accessories and more information please visit [www.shop.ford.co.uk](http://www.shop.ford.co.uk).  
 \*The identified accessories are carefully selected third party supplier branded accessories and may have different warranty conditions, the details of which can be obtained from your Ford Dealer.

## INFOTAINMENT

	Part Number	Series				
		Titanium	ST-Line	ST-Line X	ST-Line Vignale	ST
<b>AUDIO</b>						
Pioneer* Subwoofer TS-WH500A	2 409 070	Available	Available	Available	Available	Available
CD Player	2 454 323	Available	Available	Available	Available	Available

Please note that this overview does not show the complete range of products available. For further accessories and more information please visit [www.shop.ford.co.uk](http://www.shop.ford.co.uk).  
 \*The identified accessories are carefully selected third party supplier branded accessories and may have different warranty conditions, the details of which can be obtained from your Ford Dealer.



## STYLING

	Part Number	Series				
		Titanium	ST-Line	ST-Line X	ST-Line Vignale	ST
<b>BODY DESIGN</b>						
Eibach®* Pro-Spacer Kit wheel spacer System 4, black anodized	Various	↗	↗	↗	↗	↗
<b>INTERIOR DESIGN</b>						
Scuff Plates front, with Ford logo	2 417 744	↗	↗	↗	↗	—
Sports Pedal Cappings steel	1 835 213	↗	—	—	—	—
<b>SUSPENSION-LOWERING KIT</b>						
Eibach®* Suspension-Lowering Kit	1 569 237	↗	↗	↗	↗	↗

Please note that this overview does not show the complete range of products available. For further accessories and more information please visit [www.shop.ford.co.uk](http://www.shop.ford.co.uk).  
Wheel size depends on the original wheel size ordered for your vehicle. For further details, please contact your Ford dealer.



# 5 PURCHASE

Getting behind the wheel of your next new Ford is simple, with a variety of finance options.

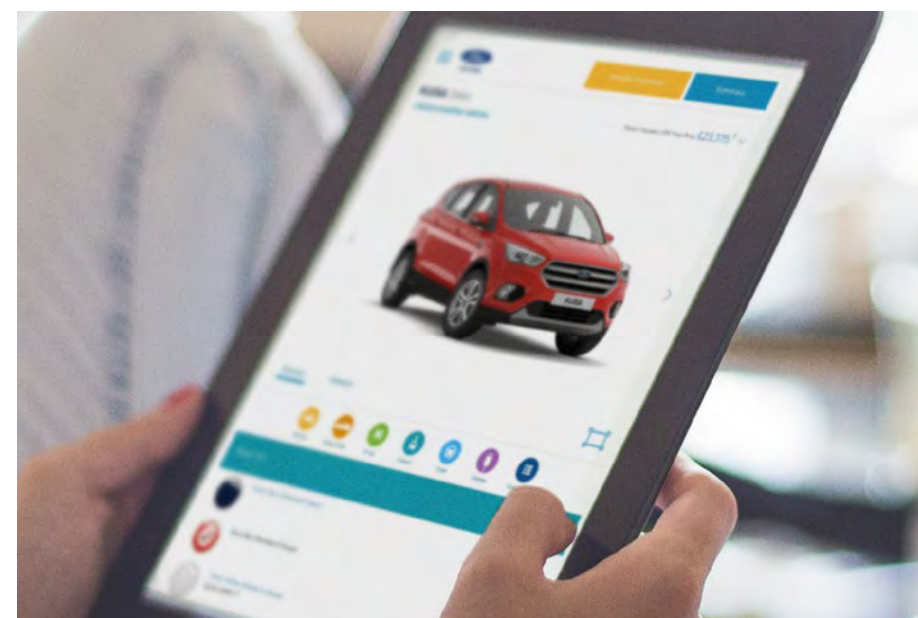

## BUILD YOUR VEHICLE

Build and personalise your vehicle online. Simply head to the Ford website, select your model, then choose your engine, body colour and extras. You'll be able to view the recommended price, and send your configuration to a Ford Dealer if you wish.

[LEARN MORE](#) 



## FIND A DEALER AND REQUEST A TEST DRIVE

You can search for a Ford Dealer by location or Dealer name on the Ford website, and request a test drive online. Simply fill in your details and your chosen Dealer will contact you to arrange a convenient time.

[LEARN MORE](#) 

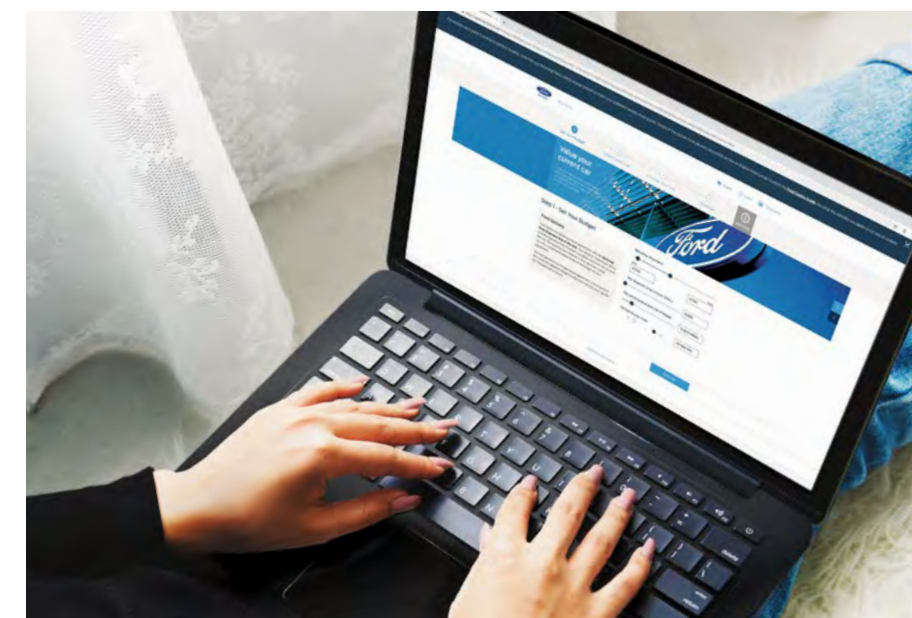

## FINANCE

When it comes to financing your vehicle, our size and expertise means we're well placed to provide you with a wide range of finance products.

**Ford Credit\*** provides a range of finance products for your vehicle whether you are a private or business user.

**Ford Lease^** specialises in contract hire and leasing and provides an alternative range of finance plans which can be tailored to suit your business.

For more information about our finance products visit

[LEARN MORE](#) 

## OWNERSHIP & PROTECT



## FORD INSURE

Designed specifically for Ford owners, Ford Insure<sup>†</sup> offers value, simplicity and a range of benefits that really matter to you.

- Repairs by experts at one of our authorised Ford Repair Centres with a courtesy car provided while your car is being repaired
- Guaranteed repairs for as long as you own your Ford
- Genuine Ford Parts and manufacturer-spec glass
- For electric and hybrid vehicles, cover for accidental damage, fire and theft of battery and standard charging equipment (excluding wall box)
- Free 24 hour emergency help lines
- Named Drivers earn a Ford Insure No Claims Bonus which can be used on any Ford Insure car insurance policy

[LEARN MORE](#) 

\*Finance subject to status. Guarantees may be required. Freepost Ford Credit.

Ford Credit is a trading style of FCE Bank plc. Which is authorised by the Prudential Regulation Authority and regulated by the Financial Conduct Authority and the Prudential Regulation Authority under firm reference number 204469.

^Ford Lease is provided by ALD Automotive Limited acting as Ford Lease BS16 7LB. ALD is registered in England No. 987418. ALD is authorised and regulated by the Financial Conduct Authority.

†Terms and conditions apply. Ford Insure contracts are arranged, administered and provided by EUI Limited. EUI Limited is a subsidiary of Admiral Group plc and is authorised and regulated by the Financial Conduct Authority (Firm reference number: 309378). Registered in England and Wales as EUI Limited Reg. No. 2686904 Registered Address: Ty Admiral, David Street, Cardiff CF10 2EH.



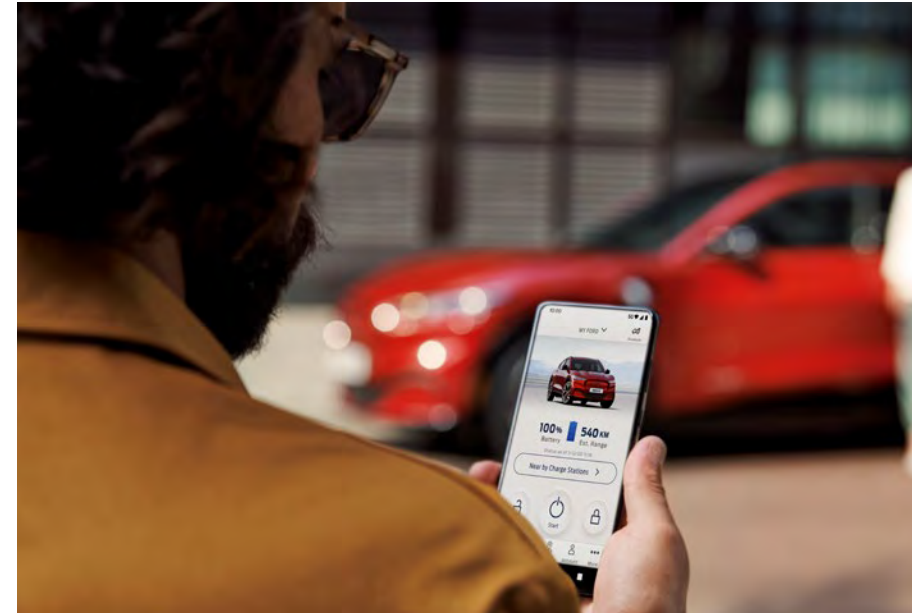

## FORDPASS APP

Unlock your car's full potential with the FordPass app. FordPass seamlessly connects you with your vehicle, keeping you moving in intelligent, intuitive ways. From optimising the route of your journey, self-diagnosing and sending you vehicle health alerts, pre-heating your vehicle before you get in, to helping you find your way back to your parked car on a map. It even removes the worry of whether you locked your car, thanks to Remote Lock and Unlock.

[LEARN MORE](#)

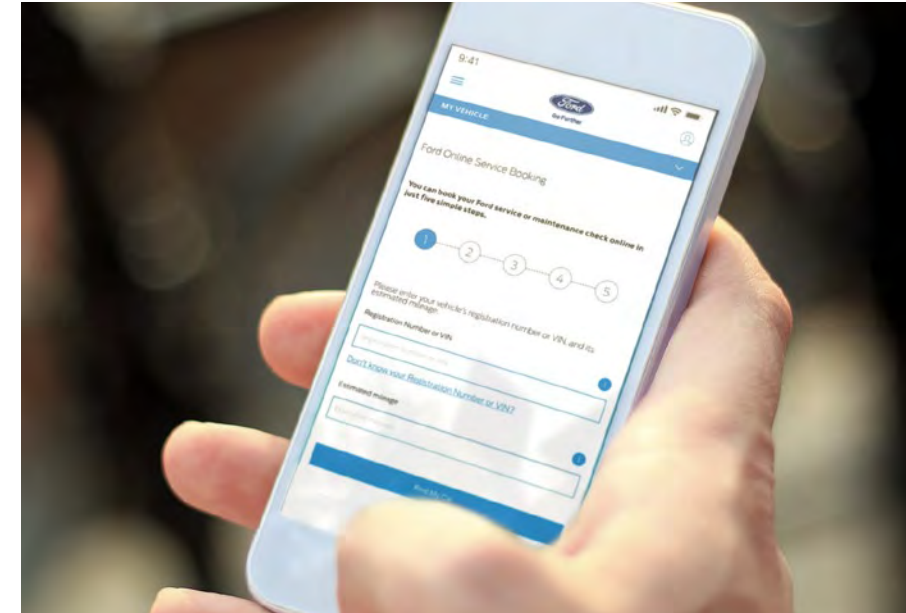

## FORD SERVICE

With Ford, the service doesn't end when you leave the showroom. Ford Service is designed to keep your Ford in great condition and help you make the most of your car throughout its life.

- Ford Online Service Booking
- Contactless servicing options, for your convenience and safety
- Comprehensive service and maintenance plans
- Use of genuine Ford parts for added peace of mind
- Ford-trained technicians using the latest diagnostic equipment and tools
- One call for everything Ford 0203 564 4444
- Ford Accident Management, service free to all drivers
- Up to 12 months' UK and European Roadside Assistance (at participating Dealers)

[LEARN MORE](#)



## FORD PROTECT

Extend your standard 3-year/60,000 miles warranty to 4 years/80,000 miles or 5 years/100,000 miles with Ford Protect. Key benefits include\*:

- High flexibility in duration and mileage
- Cover against unexpected electrical and mechanical repair costs in the UK and Europe
- The price of covered parts and labour are guaranteed for the length of your plan

Ford Protect New Vehicle Warranties are transferable to the new owner should you decide to sell your vehicle.

[LEARN MORE](#)



## FORD PROTECT SERVICE PLANS

With various payment options available, you can cover the cost of your recommended scheduled services for up to 4 years from the day your new Ford is delivered. This can work out cheaper than paying for individual services and gives you added benefits:

- Ford Assistance – your UK and European Roadside Assistance will be increased to the length of your plan
- Vehicle hire – in the event that we can't finish any warranty work within 24 hours, we'll lend you a courtesy car for up to 7 days\*\*
- A full Ford Service History, which may enhance your car's resale value

[LEARN MORE](#)

\*Ford Protect terms and conditions apply. Please call 03702 416 726.

\*\*Subject to availability and status, excluding fuel and insurance costs.



# 5 PURCHASE

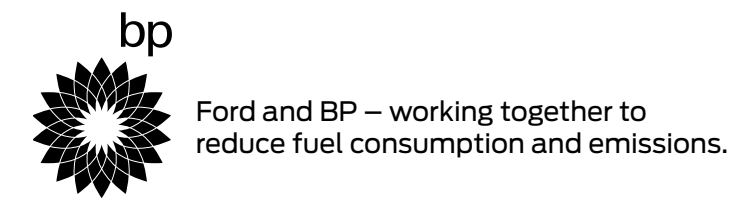

## BOOK A TEST DRIVE TODAY

The best way to discover the exciting Puma range is from behind the wheel.

Book your test drive, and your local Ford Dealer will be happy to assist you as soon as possible.

CONTACT US NOW



**Illustrations, descriptions and specifications.** This catalogue was correct at the time of going to print. However, Ford policy is one of continuous product development. The right is reserved to change specifications, colours and recommended prices of the models and items illustrated and described in this publication at any time. For the latest details always consult your Ford Dealer. **Optional equipment.** Throughout this publication, wherever a feature is described as being an 'Option' or 'Option Fitment/Pack' etc, you should assume that it will be at extra cost to the base vehicle, unless specifically stated to the contrary. All models and colour combinations are subject to availability. **Note.** Some images portrayed are of a pre-production model and/or are computer generated, therefore, the design/features on the final version of the vehicle may differ in various respects. In addition, some of the features shown on the vehicles may be optional. **Note.** This brochure contains both original Ford accessories as well as a range of products from our suppliers. Fitment of accessories may have an impact on your vehicle's fuel consumption. + The identified accessories are carefully selected third party supplier branded accessories which do not come with a Ford warranty but are covered by the third party supplier's own warranty, the details of which can be obtained from your Ford Dealer. **Note.** The Bluetooth® word mark and logos are owned by the Bluetooth SIG, Inc. and any use of such marks by Ford Motor Company is under licence. The iPod word mark and logos are the property of Apple Inc. Other trademarks and trade names are those of their respective owners. **Note.** Some driver assistance features and safety features described in this brochure are designed to function using sensors, whose performance may be affected under certain weather or environmental conditions.

**The Government fuel figures** do not express or imply any guarantee of the fuel consumption of any particular vehicle. The vehicles themselves have not been tested and there are inevitably differences between individual vehicles of the same model. In addition, a vehicle may incorporate particular modifications. Furthermore, the driver's style and road and traffic conditions, as well as the extent to which the vehicle has been driven and the standard of maintenance, will affect its fuel consumption. Insurance groups are only as recommended by the Association of British Insurers. You should always consult your insurance adviser for confirmation.

#### Ford One Call

In the unlikely event that your Ford Dealer can't help you or if you need to speak to us directly, call 0203 564 4444

#### Ford Rental – local service nationwide

Car and Van rental from our latest model range. Contact your local Ford Dealer for more information

#### Ford Motability

Call our Ford Motability team on 0345 6040019

#### Finance

Ford Credit Customer Services 0345 712 5490.  
Ford Lease Customer Services 0344 600 1405  
Calls to 0344 and 0345 numbers are charged at the same rate as a standard 01 or 02 geographic number, even when calling from a mobile.

Published by Ford Motor Company Limited, Laindon, Essex, England. Registered in England No. 235446. © Ford Motor Company Limited.

MY 2022.5

March 2022.

GBR en